

W60/W80 Series

SHUT OFF AND DIVERT VALVES



Engineering excellence, allied to stringent quality control, ensures that SPX FLOW's unrivalled range of WCB products complies with the highest international standards for hygiene. In the light of growing pressure worldwide to deliver safe, high quality food, all SPX FLOW products are designed for easy cleanability, while minimizing the use of valuable resources, such as energy.

The WCB product portfolio includes a wide range of pumps, valves, heat exchangers, mixers and homogenizers designed for use in the food, dairy and brewing industries, as well as in chemical, healthcare, pharmaceutical processing and heavy industries.

SPX FLOW, Inc. (NYSE:FLOW) is a leading manufacturer of innovative flow technologies, many of which help define the industry standard in the market segments they serve. From its headquarters in Charlotte, North Carolina, it operates a sales and support network, centers of manufacturing excellence, and advanced engineering facilities, throughout the world. Its cutting-edge flow components and process equipment portfolio includes a wide range of pumps, valves, heat exchangers, mixers, homogenizers, separators, filters, UHT, and drying technology that meet many application needs. Its expert engineering capability also makes it a premium supplier of customized solutions and complete, turn-key packages to meet the most exacting of installation demands.

Incorporating many leading brands, SPX FLOW has a long history of serving the food and beverage and industrial market sectors. Its designs and engineered solutions help customers drive efficiency and productivity, increase quality and reliability, and meet the latest regulatory demands. In-depth understanding of applications and processes, state-of-the-art Innovation Centers, and advanced pilot/testing technology further assist in optimizing processes and reducing timescales to reliably meet production targets.

To learn more about SPX FLOW capabilities, its latest technology innovations and complete service offerings, please visit www.spxflow.com.

W60/W80 Series Shut Off & Divert Valves

APPLICATION

When stopping or diverting flow in a process system, the W60 single seat valve line provides both a flexible and reliable solution. These valves are pneumatically or manually operated, and offered in a wide variety of body configurations.

Available in 1" to 6" (25mm – 152mm) OD sizes.

Adapters: Refer to page 27 for descriptions of W80 options.

MATERIALS

Product Wetted: ASTM 316L (UNS-S31603); (DIN-1.4404)

Non-Product: ASTM 304 (UNS-S30400); (DIN-1.4301)

Seat Material: Tef Flow™ (Std) See Page 3 for other available seat options.

Elastomers: FKM (Std)
EPDM (Opt)
FFKM (Opt)

Finish: $\leq 32Ra$ ($\leq 0.8 \mu m$) Other finishes available upon request

PRESSURE RATINGS

STANDARD ADAPTER					
SIZE	MAXIMUM PRESSURE AT 70°F/21°C	MAXIMUM PRESSURE AT 160°F/71°C	MAXIMUM PRESSURE AT 180°F/82°C	MAXIMUM PRESSURE AT 250°F/121°C	
1.0" 25mm	500 34	375 26	375 26	250 17	PSI Bar
1.5" 38mm	500 34	375 26	375 26	250 17	PSI Bar
2.0" 50mm	450 31	350 24	350 24	250 17	PSI Bar
2.5" 63mm	400 28	300 21	300 21	200 14	PSI Bar
3.0" 76mm	350 24	250 17	250 17	150 10	PSI Bar
4.0" 101mm	200 14	150 10	150 10	125 9	PSI Bar
6.0" 152mm	150 10	100 7	100 7	75 5	PSI Bar

Note:

*6" valves available in W61 Shutoff and W65 Divert only.

Typical Product Applications



PRESSURE RATINGS

HIGH PRESSURE ADAPTER AND CLAMPS				
SIZE	MAXIMUM PRESSURE AT 70°F/21°C	MAXIMUM PRESSURE AT 180°F/82°C	MAXIMUM PRESSURE AT 250°F/121°C	
1.0"	1220	1160	1100	PSI
25mm	84	80	76	Bar
1.5"	1220	1160	1100	PSI
38mm	84	80	76	Bar
2.0"	900	855	830	PSI
50mm	62	59	57	Bar
2.5"	720	690	660	PSI
63mm	50	48	46	Bar
3.0"	600	575	550	PSI
76mm	41	40	38	Bar
4.0"	570	546	525	PSI
101mm	39	37	36	Bar

Note:

3, 4 or 6 inch high pressure clamp not available.
For other valve types contact factory. For all valve options see Valve Key Datasheet (DS-1204).

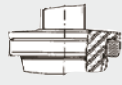
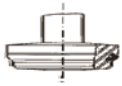
OPTIONS AND ACCESSORIES

SEAT TYPE	MAXIMUM TEMPERATURE °F / °C *	APPLICATION	SERIES
 TEF-FLOW™ (TF)	180/82	Standard seat of choice. General Purpose, >90% of applications	W60
 TEF-FLOW™ "p" (TFP)	280/137	High Temp High Pressure Pressure Relief	W60 W80
 Tri Ring (TR) EPDM, FKM	Oper. 280/137EPDM Steril. 275/135EPDM Oper. 350/176 FKM Steril. Consult Factory FKM	High Pressure Large Particulate	W60 W80
 Metal (M)	375/190	High Pressure High Flow Large Particulate	W60 W80

Note:

For higher temperature applications than those listed, please consult the factory.
*Operating conditions such as flow rate and pressure must be considered when operating near max temperature rating.

Beverage

- Beer
- Cider
- Fruit Drinks
- Liquid Sugar and Glucose
- Soft Drinks
- Wine
- Wort



Food

- Animal Oils
- Flavorings
- Pet Food
- Soups and Sauces
- Vegetable Juices
- Vegetable Oils
- Vinegars



Dairy

- Cream
- Milk
- Milk Concentrate
- Raw Milk
- Skimmed Milk
- Whey
- Whey Concentrate



Pharmaceutical and Toiletries

- Emulsions
- Extracts
- Lotions
- Perfumes
- WFI (Water for Injection)
- High Purity Water
- Pure Water

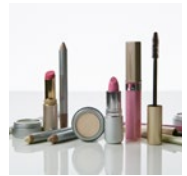

Chemical

- Additives
- Adhesives
- Coatings
- Contaminated Liquids
- Detergents
- Emulsions
- Paint



Control Tops

WAUKESHA CHERRY-BURRELL CONTROL TOP



FEATURES AND BENEFITS

- Transparent Control Top keeps all electrical components visible.
- Maintainable, designed with the user in mind, making assembly and troubleshooting worry free and easy.
- Waukesha Cherry-Burrell uses the industry's most widely recognized electrical components, so access to off the shelf replacement parts is easy, ensuring quick delivery and less down time.
- NEMA 4x (IP64)
- Stainless Steel Control Top Option



CONNECTOR OPTIONS

- S/O Cord Grip for hard wire (std)
- Quick Disconnect Pin Connectors

INTERFACE OPTIONS

- AS-i Field Bus Card
- Device Net Field Bus Network Card

POSITION INDICATION

- Set & Forget Switch
- Inductive Proximity Switches 20-140V AC/DC, 2-Wire (Std)
- Microswitches 24V DC, 110V AC
- Intrinsically safe options 5-24V DC



SOLENOID VALVES

- 24VDC or 110V AC
- Select from 0 to 3 Solenoids

CU4 & CU4plus CONTROL TOP



FEATURES AND BENEFITS

- Automated control and position monitoring for reliable processing
- Reduces compressed air and electrical connections
- Helps reduce external solenoid valve cabinets
- Accelerates valve response time
- Innovative seat lift detection is fully integrated without need for external sensor wiring to provide additional position monitoring
- Reliability and long service life - robust clamp connection, reinforced stainless steel air coupling threads to avoid air leakages, and water tight seals
- Ease of operation - contains manual override solenoids and adjustment screw to throttle air flow to actuator to ensure optimal opening and closing
- Clarity - clear and bright indication of valve position - 5 diodes in LED panel and convenient location
- Standardization - same control top used on various SPX FLOW valve lines, offers common look and controls interface
- NEMA 6 (IP67) washdown rating



CONNECTOR OPTIONS

- S/O Cord Grip for hard wire (standard)
- M12 4-pin connector (optional)

INTERFACE OPTIONS

- 24V DC Direct Connect
- AS-i Field Bus Card

POSITION INDICATION OPTIONS

- CU4: 2 internal feedback sensors for valve open/valve closed position detection
- CU4plus: Automatic teaching of all positions with press of single button

SOLENOID VALVES

- 24V DC or 110V AC
- Select 1 solenoid or solenoid with NOT element (air/air or air assist)

8681 CONTROL TOP

8681 Control Tops



FEATURES AND BENEFITS

- Contact free position sensor including (3) programmable feedback signals
- Positions easily taught via intuitive push buttons or Autotune feature to ensure quick & easy set-up
- Ultra-bright 360° visual LED position indication with adjustable red, yellow, & green color assignments provide clarity from all points of view and avoid confusion
- Manual override and air throttle adjustable solenoids to assist start-up, maintenance, and troubleshooting
- Up to IP69K washdown rating available (IP65/67 as standard) for high washdown environments
- Built-in microcontroller tracks cycles and alerts operator when preventive maintenance is required
- Simple and robust stainless steel adapter & chemically resistant polycarbonate head
- Supplied by industry leading Burkert Fluid Controls

CONNECTOR OPTIONS

- Quick Disconnect Pin Connector

INTERFACE OPTIONS

- AS-i Field Bus Card
- DeviceNet™ Field Bus Network Card
- Available on request CANOpen, IO-Link

POSITION INDICATION

- (3) programmable position sensors in control top

SOLENOID VALVES

- 24V DC
- Manual override and air throttle adjustment
- Up to (3) available in control top

Actuator Options

STROKE LENGTH

VALVE SIZE	W61/W63 W81/W83 STANDARD STROKE	W62/W65 W82/W85 STANDARD STROKE	W61/W63 W81/W83 LONG STROKE	W62/W65 W82/W85 LONG STROKE	W61 Y-BODY EXTRA LONG STROKE
1.0" 25mm	0.625 16	0.625 16	--	--	--
1.5" 38mm	0.813 21	0.688 17	--	--	--
2.0" 50mm	0.813 21	0.688 17	--	--	--
2.5" 63mm	0.813 21	0.688 17	1.870 47	1.690 43	4.200 107
3.0" 76mm	0.813 21	0.688 17	2.310 59	2.090 53	4.200 107
4.0" 101mm	0.813 21	0.688 17	3.220 82	2.940 75	5.200 132
6.0" 152mm	--	--	3.220 82	3.020 77	--

Air Volume Required

- 4" AR = 12.7 in³/81 cm³
- 4" AL = 14 in³/90 cm³
- 5" AR = 21.5 in³/138 cm³
- 5" AL = 27.1 in³/174 cm³
- 6" AR = 36.1 in³/223 cm³
- 6" AL = 33.1 in³/213 cm³

Note: Normal air supply requirement: 50 PSI for 4, 5, and 6 inch, A, B and C size actuators and long stroke actuators; 75 PSI for 4, 5, and 6 inch heavy duty spring actuators. These estimates may vary depending on other factors such as air pressure, pipe line pressure and air routing through solenoid. Standard stroke length is the same for maintainable and maintenance-free actuators.

"A" - DIMENSIONS

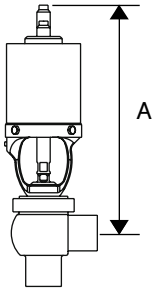

4AR-4" Air to Raise Maintainable

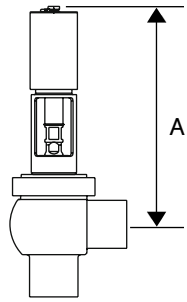

M - Micrometer

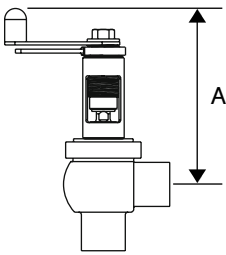

H - Hand Lock
HLG - Hand Lock, long stroke
6YLG - Hand Lock

VALVE SIZE	4 AR 4 AL 4 AA	5 AR 5 AL 5 AA	6 AR 6 AL 6 AA	4* RHAR	5* RHAR	6* RHAR	4* RHAL	5* RHAL	6* RHAL	6 ARLG ALLG
1.0" 25mm	12.58 320	13.89 353	15.65 398	-- --	-- --	-- --	-- --	-- --	-- --	-- --
1.5" 38mm	12.58 320	13.89 353	15.65 398	15.89 404	17.27 439	19.14 486	-- --	-- --	-- --	-- --
2.0" 50mm	12.83 326	14.14 359	15.90 404	16.14 410	17.62 448	19.38 492	16.42 417	17.74 451	18.72 475	-- --
2.5" 63mm	13.08 332	14.39 366	16.15 410	16.39 416	17.77 451	19.64 499	16.67 423	17.99 457	18.97 482	25.30 643
3.0" 76mm	13.33 339	14.64 372	16.40 417	16.64 423	18.02 458	19.89 505	16.92 430	18.24 463	19.22 488	25.50 648
4.0" 101mm	13.81 351	15.12 384	16.88 429	17.13 435	18.50 470	20.37 517	17.41 442	18.73 476	19.70 500	26.00 660
6.0" 152mm	-- --	-- --	-- --	-- --	-- --	-- --	-- --	-- --	-- --	27.20 691

VALVE SIZE	HLG	H	M	4AL3	4AR3	4 ALLG ARLG	6 AALG	6 ARY ALY	A1 A2 A3 **	B1 B2 B3 **	C1 C2 C3 **
1.0" 25mm	-- --	8.65 220	8.80 224	14.66 372	16.07 408	-- --	-- --	-- --	14.51 369	15.73 399	17.50 444
1.5" 38mm	-- --	8.65 220	8.80 224	14.68 373	16.07 408	-- --	-- --	-- --	14.51 369	15.73 399	17.50 444
2.0" 50mm	-- --	8.90 226	9.10 231	14.93 379	16.32 415	-- --	-- --	-- --	14.76 375	15.98 406	17.75 451
2.5" 63mm	11.60 295	9.15 232	9.30 236	15.10 384	16.57 421	23.10 587	19.70 500	36.90 937	15.01 381	16.23 412	18.00 457
3.0" 76mm	11.80 300	9.40 239	9.60 244	15.30 389	16.82 427	23.40 594	20.40 518	36.80 935	15.26 388	16.48 418	18.25 463
4.0" 101mm	12.30 312	9.88 251	10.00 254	15.80 401	17.30 439	23.90 607	21.80 554	38.10 968	15.75 400	16.96 431	18.73 476
6.0" 152mm	12.40 315	-- --	-- --	-- --	-- --	-- --	22.80 579	-- --	-- --	-- --	-- --

All "A" Dimension are in fully extended (open) position.

*For sizing Over-Pressure valves, select a Heavy-Duty spring actuator with a holding pressure greater than the desired relief pressure. Designate with the "R" the valve model (i.e. WR61) and actuator size (i.e. 5RHAR). Refer to DS-1224 for more details on Over-Pressure Valves.

CONTROL TOP DIMENSIONAL ADDER

CONTROL TOP	ACTUATOR		
	MAINTAINABLE		MAINTENANCE-FREE
	4" & 5"	6"	
WCB	4.12"	4.45"	3.75"
WCB-LONG STROKE	6.02"		N/A
CU4	3.60"		3.75"
8681	7.70"		7.20"

Note: Add control top dimension above to "A" dimension of selected valve and actuator size

Actuators

- 4AR - 4" (101mm) Air to Raise
- 4HAR³ - 4" (101mm) Air to Raise, Heavy Duty Spring
- 4RHAR⁴ - 4" (101mm) Air to Raise, Spring Adjustable, Heavy Duty Spring
- 4ARLG - 4" (101mm) Air to Raise, Long Stroke
- 4AL - 4" (101mm) Air to Lower
- 4HAL³ - 4" (101mm) Air to Lower, Heavy Duty Spring
- 4RHAL⁴ - 4" (101mm) Air to Lower, Spring Adjustable, Heavy Duty Spring
- 4ALLG - 4" (101mm) Air to Lower, Long Stroke
- 4AA - 4" (101mm) Air to Air

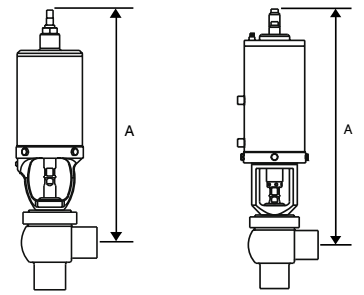

4AL3 - 4" Air to Lower, 3 position

4AR3 - 4" Air to Raise, 3 position

- 5AR - 5" (127mm) Air to Raise
- 5HAR³ - 5" (127mm) Air to Raise, Heavy Duty Spring
- 5RHAR⁴ - 5" (127mm) Air to Raise, Spring Adjustable, Heavy Duty Spring
- 5AL - 5" (127mm) Air to Lower
- 5HAL³ - 5" (127mm) Air to Lower, Heavy Duty Spring
- 5RHAL⁴ - 5" (127mm) Air to Lower, Spring Adjustable, Heavy Duty Spring
- 5AA - 5" (127mm) Air to Air

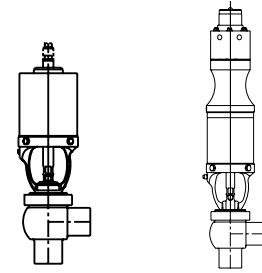

- 6AR - 6" (152mm) Air to Raise
- 6HAR³ - 6" (152mm) Air to Raise, Heavy Duty Spring
- 6RHAR⁴ - 6" (152mm) Air to Raise, Spring Adjustable, Heavy Duty Spring
- 6ARLG - 6" (152mm) Air to Raise, Long Stroke
- 6AL - 6" (152mm) Air to Lower
- 6HAL³ - 6" (152mm) Air to Lower, Heavy Duty Spring
- 6RHAL⁴ - 6" (152mm) Air to Lower, Spring Adjustable, Heavy Duty Spring
- 6ALLG - 6" (152mm) Air to Lower, Long Stroke
- 6AA - 6" (152mm) Air to Air
- 6ARY² - 6" (152mm) Air to Raise, Extra Long Stroke
- 6ALY² - 6" (152mm) Air to Lower, Extra Long Stroke

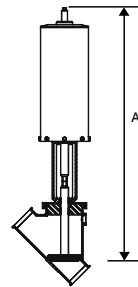

6ARY - 6" Air to Raise, extra long stroke

- 4ARP 4" (101 mm) Air to Raise w/positioner
- 4ALP 4" (101 mm) Air to Lower w/positioner

- 5ARP 5" (127 mm) Air to Raise w/positioner
- 5ALP 5" (127 mm) Air to Lower w/positioner

- 6ARP 6" (152 mm) Air to Raise w/positioner
- 6ALP 6" (152 mm) Air to Lower w/positioner

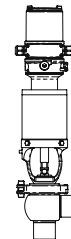

- A1 - 3" (74mm) Air to Raise
- A2 - 3" (74mm) Air to Lower
- A3 - 3" (74mm) Air to Air
- B1 - 4.5" (110mm) Air to Raise
- B2 - 4.5" (110mm) Air to Lower
- B3 - 4.5" (110mm) Air to Air
- C1 - 6.5" (165mm) Air to Raise
- C2 - 6.5" (165mm) Air to Lower
- C3 - 6.5" (165mm) Air to Air

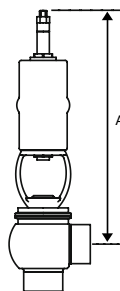

A1-3" (74mm) Air to Raise, Maintenance Free

- 4ALEP 4" (102 mm) Air to Lower, Electropneumatic Positioner
- 5ALEP 5" (127 mm) Air to Lower, Electropneumatic Positioner
- 6ALEP 6" (152 mm) Air to Lower, Electropneumatic Positioner
- 4AREP 4" (102 mm) Air to Raise, Electropneumatic Positioner
- 5AREP 5" (127 mm) Air to Raise, Electropneumatic Positioner
- 6AREP 6" (152 mm) Air to Raise, Electropneumatic Positioner

H Hand Lock
M Micrometer

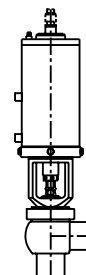
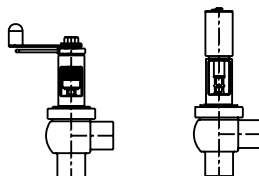

- 4AR3 4" (101 mm) Air to Raise, 3 position
- 4AL3 4" (101 mm) Air to Lower, 3 position

² Used with Y-Body valves. Consult with application engineering for use with 6" (152 mm) OD size valves.

³ Use TFP metal or TR seats for heavy spring actuators.

⁴ Used with over-pressure valves, use TFP or metal seats.

BODY CONFIGURATIONS (1 OF 2)

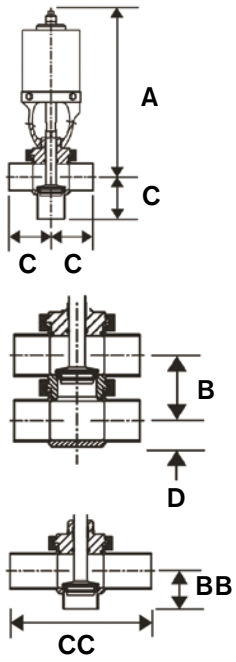

TM and CM Bodies

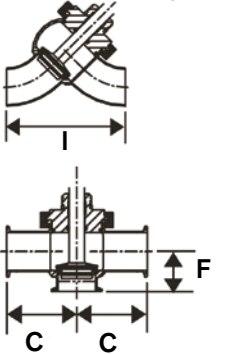
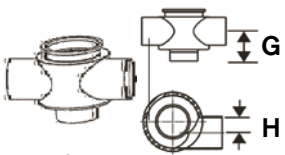

TPS and CPS Bodies

W61 Shut-off

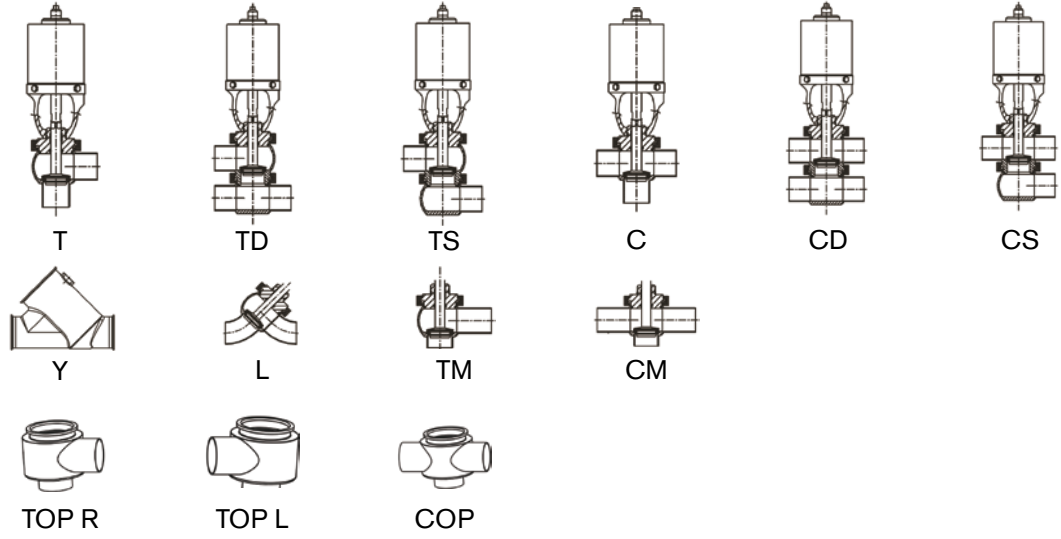

W63/W83 Shut-off (W68R/W88R Throttling)

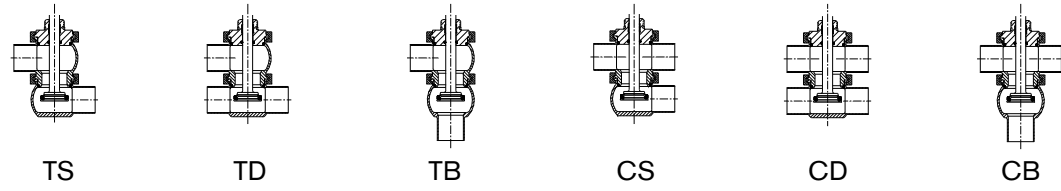

W61 and W63 Shut-off - One Piece Bodies

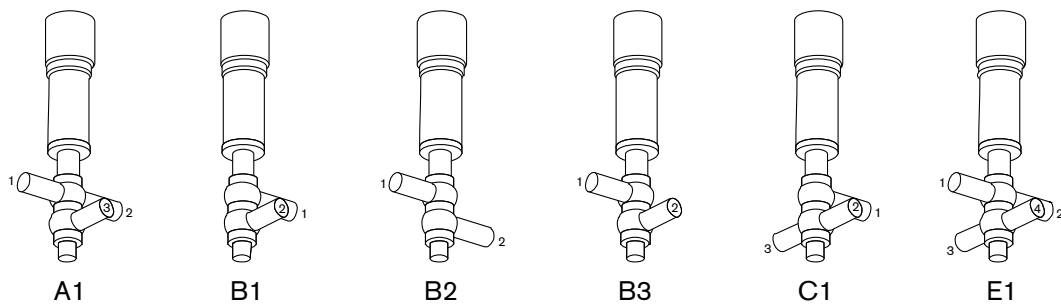

VALVE DIMENSIONS

VALVE SIZE	A	B	BB	C BUTTWELD	C S-LINE	CC	D	F S-LINE	G BUTTWELD	G S-LINE	H	I BUTTWELD	I S-LINE
1.0" 25mm	SEE PAGE 6 FOR ACTUATOR OPTIONS	2.63	1.98	2.00	3.12	8.00	0.69	1.83	2.00	2.50	0.85	4.76	6.23
		67	50	51	79	203	18	46	51	64	21	121	158
1.5" 38mm		2.63	1.84	2.25	2.75	8.00	0.94	1.69	2.00	2.50	0.60	4.76	5.85
		67	47	57	70	203	24	43	51	64	15	121	149
2.0" 50mm		3.13	2.14	3.00	3.50	8.00	1.19	1.99	2.13	2.63	0.68	6.23	7.33
		80	54	76	89	203	30	51	54	67	17	158	186
2.5" 63mm		3.63	2.38	3.00	3.50	8.00	1.44	2.27	2.38	2.88	0.81	7.69	8.79
		92	60	76	89	203	37	58	60	73	20	195	223
3.0" 76mm		4.13	2.64	3.25	3.75	8.00	1.69	2.55	2.75	3.25	0.93	9.15	10.25
		105	67	83	95	203	43	65	70	83	23	232	260
4.0" 101mm		5.11	3.11	3.88	4.50	12.00	2.32	3.15	3.25	3.88	1.09	11.95	13.29
		130	79	99	114	305	59	80	83	99	28	304	338
6.0" 152mm		7.04	--	6.00	6.88	--	4.03	--	4.00	4.88	1.44	--	--
		179	--	152	175	--	102	--	102	124	37	--	--

BODY CONFIGURATIONS (2 OF 2)

W62/W82 Divert

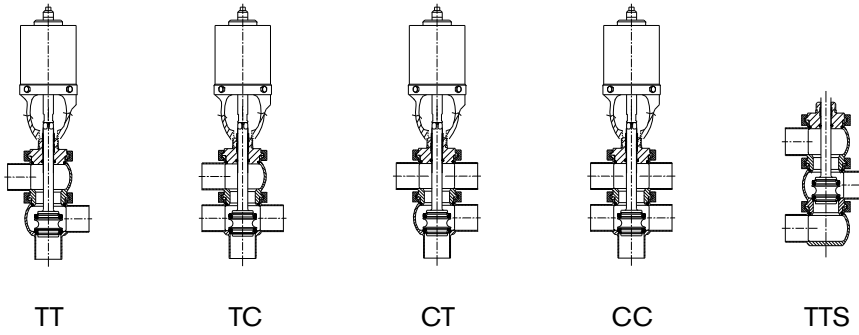

W65/W85 Divert (W685/W885 Throttling)

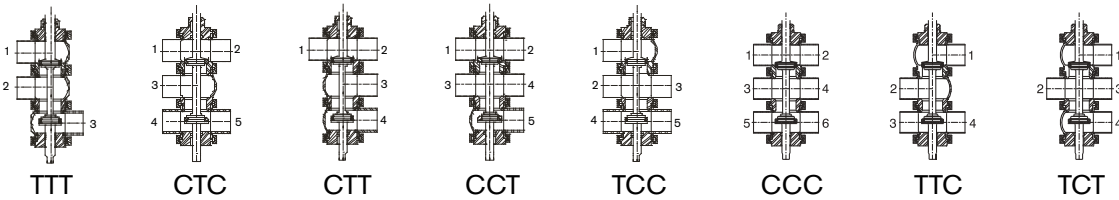

W64/W84 Tank Outlet (NOTE: Tank Flanges sold separately)

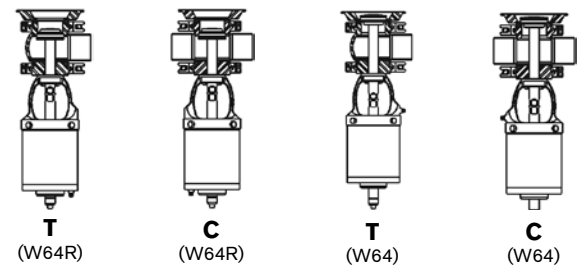

W265/W285 FDV W262/W282 FDV

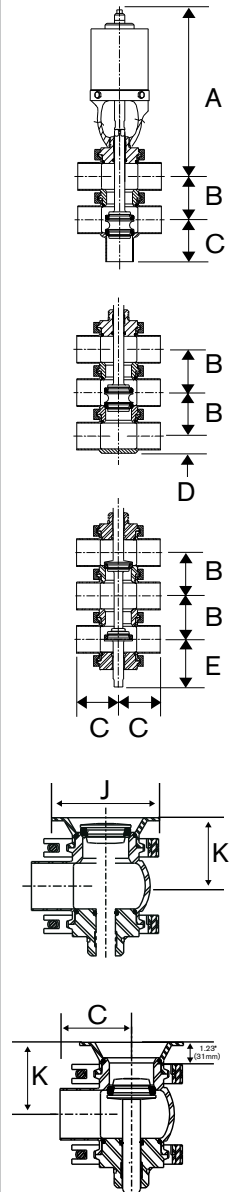
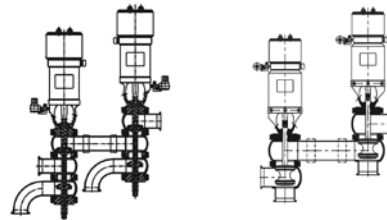

VALVE DIMENSIONS

VALVE SIZE	A	B	C BUTTWELD	C S-LINE	D	E	J	K
1.0" 25mm	SEE PAGE 6 FOR ACTUATOR OPTIONS	2.63	2.00	3.12	0.69	3.91	5.00	2.54
		67	51	79	18	99	127	65
1.5" 38mm		2.63	2.25	2.75	0.94	3.97	5.00	2.54
		67	57	70	24	101	127	65
2.0" 50mm		3.13	3.00	3.50	1.19	4.22	5.00	2.79
		80	76	89	30	107	127	71
2.5" 63mm		3.63	3.00	3.50	1.44	4.55	5.50	3.04
		92	76	89	37	116	140	77
3.0" 76mm		4.13	3.25	3.75	1.69	4.73	6.00	3.29
		105	83	95	43	120	152	84
4.0" 101mm	5.11	3.88	4.50	2.32	5.06	6.00	3.79	
	130	99	114	59	129	152	96	
6.0" 152mm	7.04	6.00	6.88	4.03	6.20	--	--	
	179	152	175	102	157	--	--	

Pressure Loss Curves

W80 valves are charted below under corresponding W60 header. Curves are based on water 70°F (21°C).

MODEL W61 & W64R

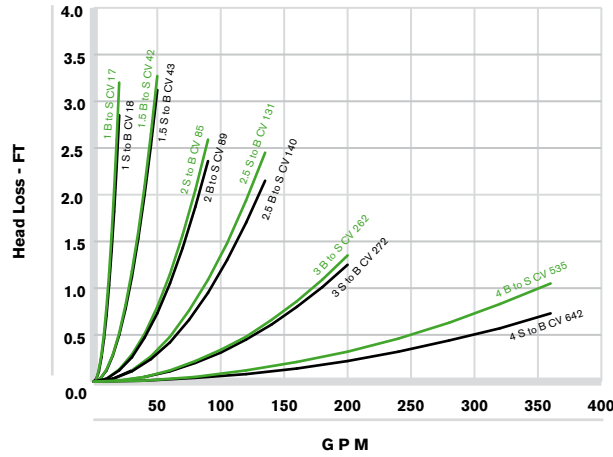
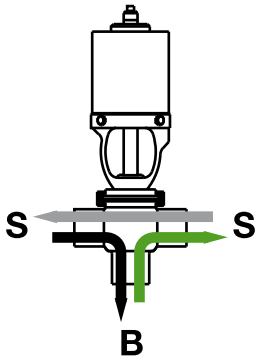

*Note: For W61 S to S curves see W62 T to T curves.

MODEL W63 & W64

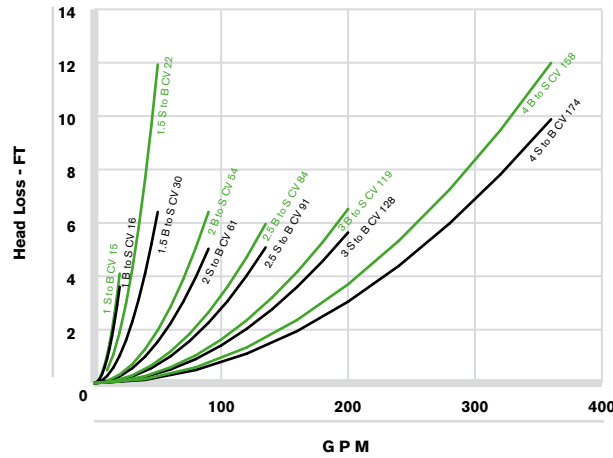
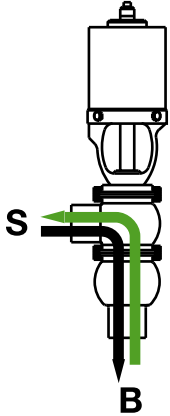

MODEL W62

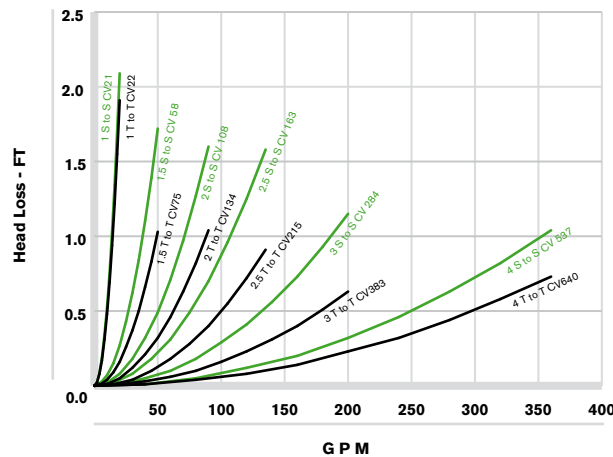
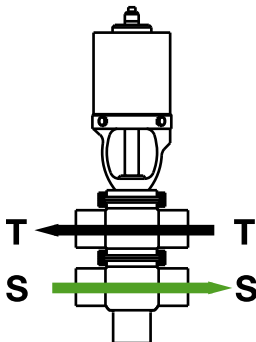

MODEL W62

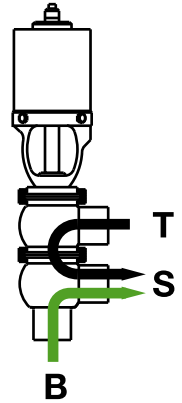
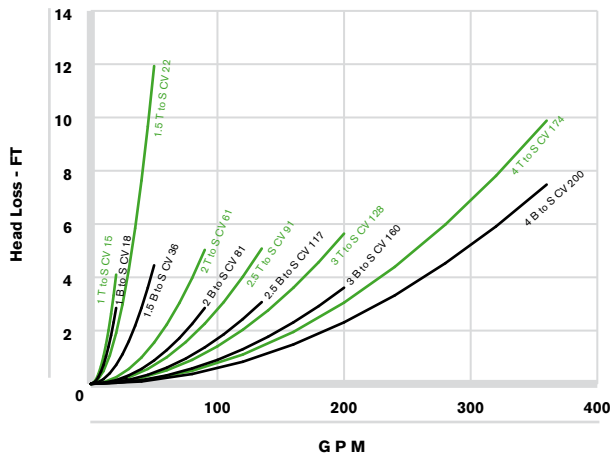

MODEL W62

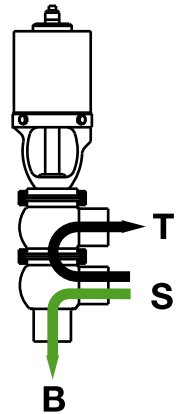
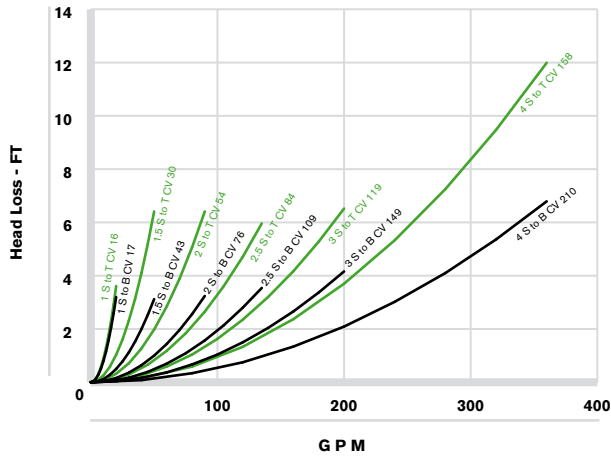

MODEL W65

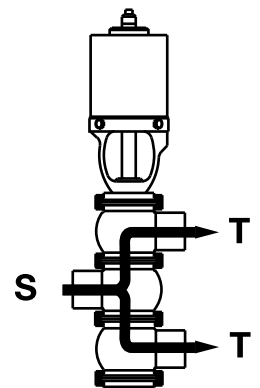
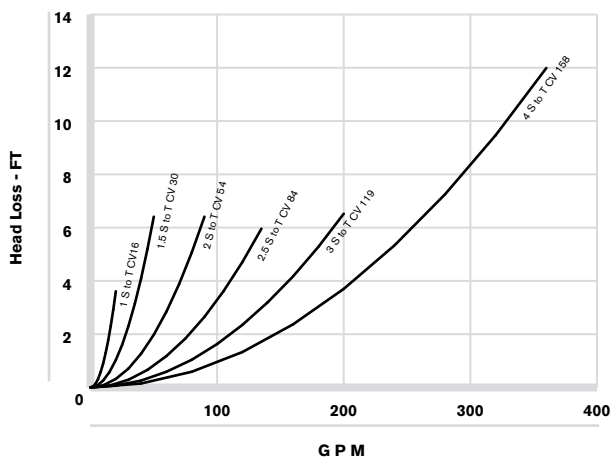

NOTE: Pressure drop curves shown are for estimation purposes only. Contact application engineering for specific pressure drop details.

W61 & W64R Holding Pressure Charts

W80 Holding Pressures are charted under the corresponding W60 header.

- If pressure rating is higher than documented in tables consult factory before exceeding.
- Minimum air supply requirements: 50 PSI for 4, 5 and 6 inch standard spring actuators; 75 PSI for 4, 5 and 6 inch heavy spring and 4 and 6 inch long stroke actuators; 87 PSI for A, B and C size actuators.
- For sizing Over-Pressure valves, select a Heavy-Duty spring actuator with a holding pressure greater than the desired relief pressure. Designate with the "R" valve model (i.e. WR61) and actuator size (i.e. 5RHAR).
- Please contact the factory for holding pressure values not listed.

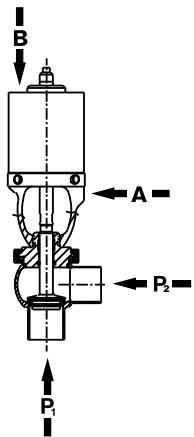

VALVE SIZE	ACTUATOR SIZE									
	BOTTOM PORT (P ₁), ACTUATOR SPRING HOLDS CLOSED AGAINST:									
	4AR	4HAR	5AR	5HAR	6AR	6HAR	A1	B1	C1	
1.0"	160	213	251	--	347	--	--	--	--	PSI
25mm	11	15	17	--	24	--	--	--	--	Bar
1.5"	125	177	220	378	317	--	96	273	--	PSI
38mm	9	12	15	26	22	--	7	19	--	Bar
2.0"	70	99	124	212	178	338	54	153	370	PSI
50mm	5	7	9	15	12	23	4	11	26	Bar
2.5"	45	64	79	136	114	216	34	98	236	PSI
63mm	3	4	5	9	8	15	2	7	16	Bar
3.0"	31	44	55	94	79	150	24	68	164	PSI
76mm	2	3	4	6	5	10	2	5	11	Bar
4.0"	18	25	31	54	45	87	13	38	92	PSI
101mm	1	2	2	4	3	6	1	3	6	Bar

VALVE SIZE	ACTUATOR SIZE									
	SIDE PORT (P ₂), AIR TO PORT A, WILL OPEN AGAINST:									
	4AR 50PSI/ 3BAR	4HAR 75PSI/ 5BAR	5AR 50PSI/ 3BAR	5HAR 75PSI/ 5BAR	6AR 50PSI/ 3BAR	6HAR 75PSI/ 5BAR	A1 50PSI/ 3BAR	B1 50PSI/ 3BAR	C1 50PSI/ 3BAR	
1.0"	223	371	356	--	--	--	67	127	--	PSI
25mm	15	26	25	--	--	--	5	9	--	Bar
1.5"	270	419	398	--	--	--	67	127	--	PSI
38mm	19	29	27	--	--	--	5	9	--	Bar
2.0"	132	205	195	261	278	334	33	62	123	PSI
50mm	9	14	13	18	19	23	2	4	8	Bar
2.5"	80	124	118	158	168	202	20	38	74	PSI
63mm	6	9	8	11	12	14	1	3	5	Bar
3.0"	54	84	79	106	113	136	13	25	50	PSI
76mm	4	6	5	7	8	9	1	2	3	Bar
4.0"	29	45	43	57	61	72	7	14	27	PSI
101mm	2	3	3	4	4	5	0	1	2	Bar

W61Y-BODY (AIR-TO-RAISE) - EXTRA LONG STROKE

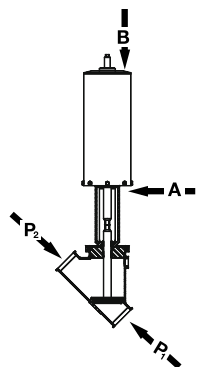

Note: Y-Body must use 6ARY/AL Actuator

VALVE SIZE	ACTUATOR SIZE		
	PORT (P ₁), ACTUATOR SPRING HOLDS CLOSED AGAINST:		
	6ARY	6ARY 50PSI/3BAR	
2.5"	44	52	PSI
63mm	3	3	Bar
3.0"	34	35	PSI
76mm	2	2	Bar
4.0"	16	16	PSI
101mm	1	1	Bar

W61 AR (AIR-TO-RAISE) - LONG STROKE

VALVE SIZE	ACTUATOR SIZE						PSI Bar
	BOTTOM PORT (P ₁), ACTUATOR SPRING HOLDS CLOSED AGAINST:			SIDE PORT (P ₂), AIR TO PORT A, WILL OPEN AGAINST:			
	4ARLG 50PSI/ 3BAR	6ARLG 50PSI/ 3BAR	6ARY 50PSI/ 3BAR	4ARLG 50PSI/ 3BAR	6ARLG 50PSI/ 3BAR	6ARY 50PSI/ 3BAR	
2.5" 63mm	33 2	112 8	--	93 6	170 12	--	PSI Bar
3.0" 76mm	23 2	80 6	--	63 4	112 8	--	PSI Bar
4.0" 101mm	13 1	44 3	--	34 2	62 4	--	PSI Bar
6" 152mm	--	21 2	15 1	--	30 2	29 2	PSI Bar

W61 AL/HAL (AIR-TO-LOWER) - STANDARD STROKE

VALVE SIZE	ACTUATOR SIZE									
	BOTTOM PORT (P ₁), AIR TO PORT B ₁ , WILL HOLD AGAINST:									
	4AL 50PSI/ 3BAR	4HAL 75PSI/ 5BAR	5AL 50PSI/ 3BAR	5HAL 75PSI/ 5BAR	6AL 50PSI/ 3BAR	6HAL 75PSI/ 5BAR	A2 50PSI/ 3BAR	B2 50PSI/ 3BAR	C2 50PSI/ 3BAR	PSI Bar
1.0" 25mm	111 8	221 15	218 15	245 17	383 26	328 23	--	--	--	PSI Bar
1.5" 38mm	76 5	185 13	187 13	184 13	353 24	213 15	31 2	43 3	--	PSI Bar
2.0" 50mm	43 3	104 7	105 7	104 7	198 14	120 8	18 1.2	24 2	46 3	PSI Bar
2.5" 63mm	27 2	66 5	67 5	66 5	127 9	77 5	11 0.8	16 1.1	30 2	PSI Bar
3.0" 76mm	19 1	46 3	47 3	46 3	88 6	53 4	8 0.5	11 0.8	21 1.4	PSI Bar
4.0" 101mm	11 1	27 2	27 2	27 2	50 3	32 2	4 0.3	6 0.4	12 1	PSI Bar

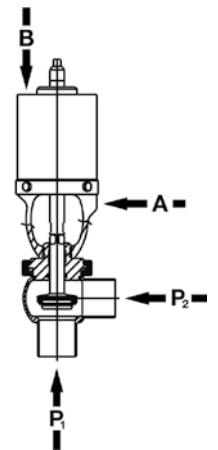

VALVE SIZE	ACTUATOR SIZE									
	SIDE PORT (P ₂), (STEM LOWERED) ACTUATOR SPRING OPENS STEM AGAINST:									
	4AL	4HAL	5AL	5HAL	6AL	6HAL	A2	B2	C2	PSI Bar
1.0" 25mm	288 20	361 25	--	--	--	--	--	--	--	PSI Bar
1.5" 38mm	300 21	409 28	--	--	--	--	154 11	430 30	--	PSI Bar
2.0" 50mm	164 11	200 14	216 15	388 27	260 18	--	76 5	211 15	502 35	PSI Bar
2.5" 63mm	99 7	121 8	131 9	234 16	157 11	361 25	46 3	127 9	303 21	PSI Bar
3.0" 76mm	67 5	81 6	88 6	158 11	106 7	243 17	31 2	86 6	204 14	PSI Bar
4.0" 101mm	36 2	44 3	47 3	85 6	57 4	131 9	17 1	47 3	112 8	PSI Bar

W61 AL (AIR-TO-LOWER) - LONG STROKE

VALVE SIZE	ACTUATOR SIZE						
	SIDEPORT (P ₂), ACTUATOR SPRING OPENS STEM AGAINST:			PORT (P1), AIR TO PORT B, WILL HOLD CLOSED AGAINST:			
	4ALLG	6ALLG	6ALY	4ALLG 50PSI/ 3BAR	6ALLG 50PSI/ 3BAR	6ALY 50PSI/ 3BAR	
2.5" 63mm	53 4	147 10	--	69 5	136 9	--	PSI Bar
3.0" 76mm	39 3	104 7	--	45 3	90 6	--	PSI Bar
4.0" 101mm	24 2	60 4	--	23 2	47 3	--	PSI Bar
6.0" 152mm	--	29 2	29 2	--	23 2	17 1	PSI Bar

W61Y-BODY (AIR-TO-LOWER) - EXTRA LONG STROKE

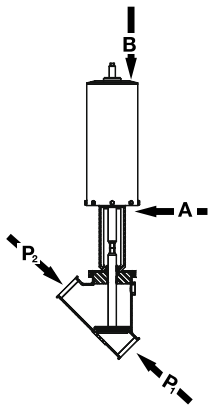

VALVE SIZE	ACTUATOR SIZE		
	PORT (P ₁), ACTUATOR SPRING HOLDS CLOSED AGAINST:	PORT (P ₂), AIR TO PORT A, WILL OPEN AGAINST:	
	6ALY	6ALY 50PSI/3BAR	
2.5" 63mm	57 4	52 4	PSI Bar
3.0" 76mm	46 3	35 2	PSI Bar
4.0" 101mm	27 2	16 1	PSI Bar

W62 Holding Pressure Charts

- If pressure rating is higher than documented in tables consult factory before exceeding.
- Minimum air supply requirements: 50 PSI for 4, 5 and 6 inch standard spring actuators; 75 PSI for 4, 5 and 6 inch heavy spring and 4 and 6 inch long stroke actuators; 87 PSI for A, B and C size actuators.
- Please contact the factory for holding pressure values not listed.

W62 AR/HAR (AIR-TO-RAISE) - STANDARD STROKE

VALVE SIZE	ACTUATOR SIZE									
	BOTTOM PORT (P ₁), ACTUATOR SPRING HOLDS CLOSED AGAINST:									
	4AR	4HAR	5AR	5HAR	6AR	6HAR	A1	B1	C1	
1.0"	125	177	220	378	317	--	84	269	641	PSI
25mm	9	12	15	26	22	--	6	19	44	Bar
1.5"	125	177	220	378	317	--	84	269	641	PSI
38mm	9	12	15	26	22	--	6	19	44	Bar
2.0"	70	99	124	212	178	338	48	156	372	PSI
50mm	5	7	9	15	12	23	3	11	26	Bar
2.5"	45	64	79	136	114	216	32	102	243	PSI
63mm	3	4	5	9	8	15	2	7	17	Bar
3.0"	31	44	55	94	79	150	22	72	171	PSI
76mm	2	3	4	6	5	10	2	5	12	Bar
4.0"	19	26	32	55	45	88	13	41	98	PSI
101mm	1	2	2	4	3	6	1	3	7	Bar

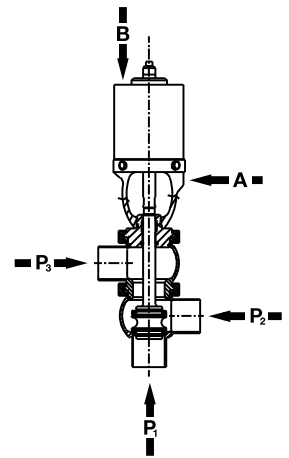

VALVE SIZE	ACTUATOR SIZE									
	SIDE PORT (P ₂), AIR TO ACTUATOR (WITH STEM RAISED), SPRING WILL LOWER AGAINST:									
	4AR	4HAR	5AR	5HAR	6AR	6HAR	A1	B1	C1	
1.0"	238	293	320	--	--	--	84	269	641	PSI
25mm	16	20	22	--	--	--	6	19	44	Bar
1.5"	253	308	333	--	--	--	84	269	641	PSI
38mm	17	21	23	--	--	--	6	19	44	Bar
2.0"	142	173	187	336	239	--	48	156	3	PSI
50mm	10	12	13	23	16	--	3	11	26	Bar
2.5"	91	111	120	215	153	367	32	102	2	PSI
63mm	6	8	8	15	11	25	2	7	17	Bar
3.0"	63	77	83	149	106	255	22	72	171	PSI
76mm	4	5	6	10	7	18	2	5	12	Bar
4.0"	37	44	48	86	61	147	13	41	98	PSI
101mm	3	3	3	6	4	10	10	1	3	Bar

W62 AR/HAR (AIR-TO-RAISE) - STANDARD STROKE (CONTINUED)

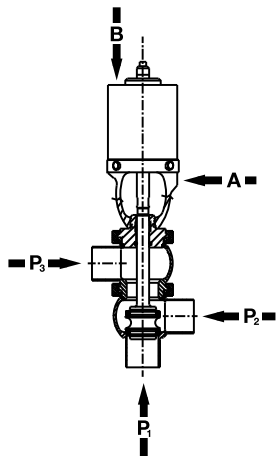

VALVE SIZE	ACTUATOR SIZE									
	PORT (P ₂), AIR TO PORT A, WILL RAISE STEM (OPENS) AGAINST:									
	4AR 50PSI/ 3BAR	4HAR 75PSI/ 5BAR	5AR 50PSI/ 3BAR	5HAR 75PSI/ 5BAR	6AR 50PSI/ 3BAR	6HAR 75PSI/ 5BAR	A1 50PSI/ 3BAR	B1 50PSI/ 3BAR	C1 50PSI/ 3BAR	
1.0"	270	419	398	--	--	--	45	46	92	PSI
25mm	19	29	27	--	--	--	3	3	6	Bar
1.5"	270	419	398	--	--	--	45	46	92	PSI
38mm	19	29	27	--	--	--	3	3	6	Bar
2.0"	132	205	195	261	278	334	23	24	48	PSI
50mm	9	14	13	18	19	23	2	2	3	Bar
2.5"	80	124	118	158	168	202	14	15	30	PSI
63mm	6	9	8	11	12	14	1	1	2	Bar
3.0"	54	84	79	106	113	136	10	10	20	PSI
76mm	4	6	5	7	8	9	1	1	1	Bar
4.0"	28	44	42	56	61	71	5	6	11	PSI
101mm	2	3	3	4	4	5	0	0	1	Bar

VALVE SIZE	ACTUATOR SIZE									
	PORT (P ₂), AIR TO PORT A, (WITH STEM RAISED), WILL HOLD AGAINST:									
	4AR 50PSI/ 3BAR	4HAR 75PSI/ 5BAR	5AR 50PSI/ 3BAR	5HAR 75PSI/ 5BAR	6AR 50PSI/ 3BAR	6HAR 75PSI/ 5BAR	A1 50PSI/ 3BAR	B1 50PSI/ 3BAR	C1 50PSI/ 3BAR	
1.0"	118	264	264	272	438	185	45	46	92	PSI
25mm	8	18	18	19	30	13	3	3	6	Bar
1.5"	99	244	247	239	421	121	45	46	92	PSI
38mm	7	17	17	16	29	8	3	3	6	Bar
2.0"	48	119	121	117	206	59	23	24	48	PSI
50mm	3	8	8	8	14	4	2	2	3	Bar
2.5"	29	72	73	71	125	36	14	15	30	PSI
63mm	2	5	5	5	9	2	1	1	2	Bar
3.0"	20	49	49	48	84	24	10	10	20	PSI
76mm	1	3	3	3	6	2	1	1	1	Bar
4.0"	10	25	26	24	45	9	5	6	11	PSI
101mm	1	2	2	2	3	1	0	0	1	Bar

W62 AR (AIR-TO-RAISE) - LONG STROKE

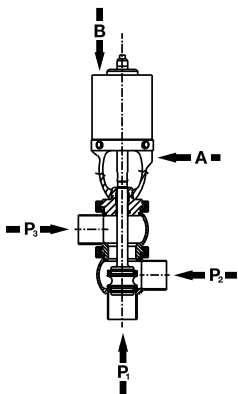

VALVE SIZE	ACTUATOR SIZE								
	PORT (P ₁), ACTUATOR SPRING HOLDS CLOSED AGAINST:		PORT (P ₂), AIR TO ACTUATOR (WITH STEM RAISED), SPRING WILL LOWER AGAINST:		PORT (P ₂), AIR TO PORT A, WILL RAISE STEM (OPENS) AGAINST:		PORT (P ₃), AIR TO PORT A, WITH STEM RAISED WILL HOLD AGAINST:		
	4ARLG	6ARLG	4ARLG	6ARLG	4ARLG	6ARLG	4ARLG	6ARLG	
2.5"	33	112	49	135	93	170	75	145	PSI
63mm	2	8	3	9	6	12	5	10	Bar
3.0"	23	78	36	97	63	114	48	94	PSI
76mm	2	5	2	7	4	8	3	6	Bar
4.0"	13	44	23	59	34	62	23	47	PSI
101mm	1	3	2	4	2	4	2	3	Bar

W62 AL (AIR-TO-LOWER) - LONG STROKE

ACTUATOR SIZE	ACTUATOR SIZE								PSI Bar
	PORT (P ₁), AIR TO PORT B HOLDS CLOSED AGAINST:		PORT (P ₂), (STEM LOWERED) SPRING OPENS STEM AGAINST:		PORT (P ₂), AIR TO PORT B, (WITH STEM RAISED) WILL CLOSE STEM AGAINST:		PORT (P ₃), (STEM RAISED) ACTUATOR SPRING HOLDS AGAINST:		
	4ALLG	6ALLG	4ALLG	6ALLG	4ALLG	6ALLG	4ALLG	6ALLG	
2.5" 63mm	69 5	135 9	54 4	148 10	85 6	158 11	36 2	123 8	PSI Bar
3.0" 76mm	45 3	91 6	39 3	103 7	59 4	110 8	24 2	83 6	PSI Bar
4.0" 101mm	22 2	47 3	24 2	61 4	33 2	62 4	13 1	45 3	PSI Bar

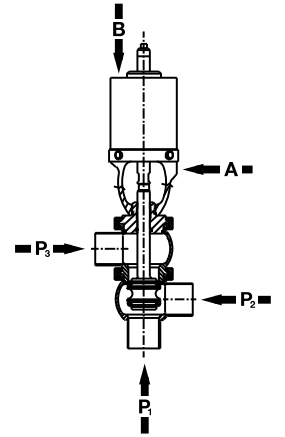

W62 AL/HAL (AIR-TO-LOWER) - STANDARD STROKE

VALVE SIZE	ACTUATOR SIZE									PSI Bar
	BOTTOM PORT (P ₁), AIR TO PORT B, WILL HOLD AGAINST:									
	4AL 50PSI/ 3BAR	4HAL 75PSI/ 5BAR	5AL 50PSI/ 3BAR	5HAL 75PSI/ 5BAR	6AL 50PSI/ 3BAR	6HAL 75PSI/ 5BAR	A2 50PSI/ 3BAR	B2 50PSI/ 3BAR	C2 50PSI/ 3BAR	
1.0" 25mm	76 5	185 13	187 13	184 13	353 24	213 15	33 2	69 5	162 11	PSI Bar
1.5" 38mm	76 5	185 13	187 13	184 13	353 24	213 15	33 2	69 5	162 11	PSI Bar
2.0" 50mm	43 3	104 7	105 7	104 7	198 14	120 8	19 1	40 3	94 6	PSI Bar
2.5" 63mm	27 2	66 5	67 5	66 5	127 9	77 5	12 1	26 2	61 4	PSI Bar
3.0" 76mm	19 1	46 3	47 3	46 3	88 6	53 4	9 1	18 1	43 3	PSI Bar
4.0" 101mm	16 1	27 2	27 2	28 2	50 3	33 2	5 0	10 1	25 2	PSI Bar

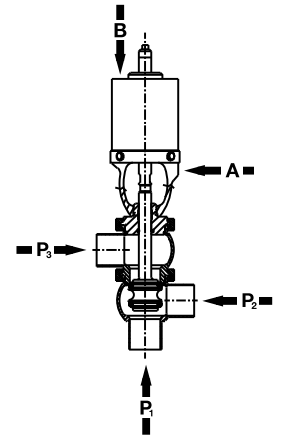

VALVE SIZE	ACTUATOR SIZE									PSI Bar
	SIDE PORT (P ₂), (STEM LOWERED), SPRING OPENS STEM AGAINST:									
	4AL	4HAL	5AL	5HAL	6AL	6HAL	A2	B2	C2	
1.0" 25mm	335 23	409 28	--	--	--	--	109 8	307 21	750 52	PSI Bar
1.5" 38mm	335 23	409 28	441 30	--	--	--	109 8	307 21	750 52	PSI Bar
2.0" 50mm	164 11	200 14	216 15	388 27	260 18	--	57 4	159 11	390 27	PSI Bar
2.5" 63mm	99 7	121 8	131 9	234 16	157 11	361 25	35 2	99 7	242 17	PSI Bar
3.0" 76mm	67 5	81 6	88 6	158 11	106 7	243 17	24 2	68 5	166 11	PSI Bar
4.0" 101mm	31 2	43 3	47 3	84 6	57 4	129 9	13 1	38 3	92 6	PSI Bar

W62 AL/HAL (AIR-TO-LOWER) - STANDARD STROKE (CONTINUED)

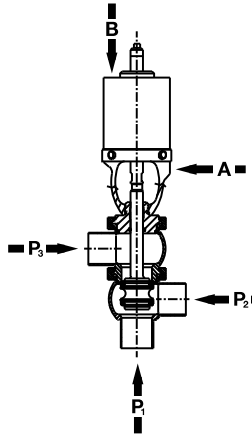

VALVE SIZE	ACTUATOR SIZE									
	BOTTOM PORT (P ₂), AIR TO PORT B, (WITH STEM RAISED), WILL CLOSE STEM AGAINST:									
	4AL 50PSI/ 3BAR	4HAL 75PSI/ 5BAR	5AL 50PSI/ 3BAR	5HAL 75PSI/ 5BAR	6AL 50PSI/ 3BAR	6HAL 75PSI/ 5BAR	A2 50PSI/ 3BAR	B2 50PSI/ 3BAR	C2 50PSI/ 3BAR	
1.0"	189	301	288	379	--	--	33	69	162	PSI
25mm	13	21	20	26	--	--	2	5	11	Bar
1.5"	204	316	301	404	--	--	33	69	162	PSI
38mm	14	22	21	28	--	--	2	5	11	Bar
2.0"	115	176	169	227	260	356	19	40	94	PSI
50mm	8	12	12	16	18	25	1	3	6	Bar
2.5"	73	114	108	145	166	227	12	26	61	PSI
63mm	5	8	7	10	11	16	1	2	4	Bar
3.0"	51	79	75	101	115	158	9	18	43	PSI
76mm	4	5	5	7	8	11	1	1	3	Bar
4.0"	32	45	43	59	66	92	5	10	25	PSI
101mm	2	3	3	4	5	6	0	1	2	Bar

VALVE SIZE	ACTUATOR SIZE									
	PORT (P ₂), (STEM RAISED), ACTUATOR SPRING HOLDS AGAINST:									
	4AL	4HAL	5AL	5HAL	6AL	6HAL	A2	B2	C2	
1.0"	184	253	300	531	402	--	109	307	750	PSI
25mm	13	17	21	37	28	--	8	21	52	Bar
1.5"	164	233	290	497	385	--	109	307	750	PSI
38mm	11	16	20	34	27	--	8	21	52	Bar
2.0"	81	114	142	244	189	323	57	159	390	PSI
50mm	6	8	10	17	13	22	4	11	27	Bar
2.5"	49	69	86	147	114	195	35	99	242	PSI
63mm	3	5	6	10	8	13	2	7	17	Bar
3.0"	33	46	58	99	77	131	24	68	166	PSI
76mm	2	3	4	7	5	9	2	5	11	Bar
4.0"	15	24	31	52	41	68	13	38	92	PSI
101mm	1	2	2	4	3	5	1	3	6	Bar

W63 & 64 Holding Pressure Charts

- If pressure rating is higher than documented in tables consult factory before exceeding.
- Minimum air supply requirements: 50 PSI for 4, 5 and 6 inch standard spring actuators; 75 PSI for 4, 5 and 6 inch heavy spring and 4 and 6 inch long stroke actuators; 87 PSI for A, B and C size actuators.
- ¹For sizing Over-Pressure valves, select a Heavy-Duty spring actuator with a holding pressure greater than the desired relief pressure. Designate with the "R" valve model (i.e. WR61) and actuator size (i.e. 5RHAR).
- Please contact the factory for holding pressure values not listed.

W63 AR/HAR (AIR-TO-RAISE) - STANDARD STROKE

VALVE SIZE	ACTUATOR SIZE									
	BOTTOM PORT (P ₂), STEM RAISED, ACTUATOR SPRING WILL OPEN AGAINST:									
	4AR	4HAR	5AR	5HAR ¹	6AR	6HAR	A1	B1	C1	
1.0"	203	257	289	--	384	--	--	--	--	PSI
25mm	14	18	20	--	26	--	--	--	--	Bar
1.5"	253	308	333	--	426	--	--	--	--	PSI
38mm	17	21	23	--	29	--	--	--	--	Bar
2.0"	142	173	187	336	239	--	--	--	--	PSI
50mm	10	12	13	23	16	--	--	--	--	Bar
2.5"	91	111	120	215	153	367	--	--	--	PSI
63mm	6	8	8	15	11	25	--	--	--	Bar
3.0"	63	77	83	149	106	255	--	--	--	PSI
76mm	4	5	6	10	7	18	--	--	--	Bar
4.0"	37	44	48	86	61	147	--	--	--	PSI
101mm	3	3	3	6	4	10	--	--	--	Bar

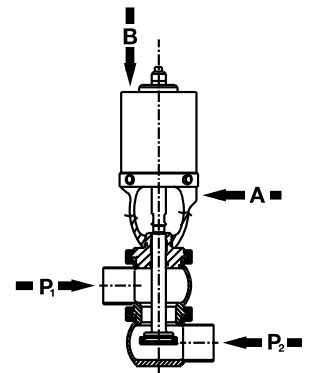

VALVE SIZE	ACTUATOR SIZE									
	PORT (P ₁), AIR TO PORT A, WILL HOLD VALVE CLOSED AGAINST:									
	4AR 50PSI/ 3BAR	4HAR ¹ 75PSI/ 5BAR	5AR 50PSI/ 3BAR	5HAR ¹ 75PSI/ 5BAR	6AR 50PSI/ 3BAR	6HAR ¹ 75PSI/ 5BAR	A1 50PSI/ 3BAR	B1 50PSI/ 3BAR	C1 50PSI/ 3BAR	
1.0"	165	312	305	353	478	339	--	--	--	PSI
25mm	11	22	21	24	33	23	--	--	--	Bar
1.5"	99	244	247	239	421	121	--	--	--	PSI
38mm	7	17	17	16	29	8	--	--	--	Bar
2.0"	48	119	121	117	206	59	--	--	--	PSI
50mm	3	8	8	8	14	4	--	--	--	Bar
2.5"	29	72	73	71	125	36	--	--	--	PSI
63mm	2	5	5	5	9	2	--	--	--	Bar
3.0"	20	49	49	48	84	24	--	--	--	PSI
76mm	1	3	3	3	6	2	--	--	--	Bar
4.0"	10	25	26	24	45	9	--	--	--	PSI
101mm	1	2	2	2	3	1	--	--	--	Bar

W63 AR (AIR-TO-RAISE) - LONG STROKE

VALVE SIZE	ACTUATOR SIZE				
	PORT (P ₂), STEM RAISED, ACTUATOR SPRING WILL OPEN AGAINST:		PORT (P ₁), AIR TO PORT A, WILL HOLD VALVE CLOSED AGAINST:		
	4ARLG	6ARLG	4ARLG	6ARLG	
2.5"	48	131	77	149	PSI
63mm	3	9	5	10	Bar
3.0"	37	97	48	94	PSI
76mm	3	7	3	6	Bar
4.0"	23	58	23	47	PSI
101mm	2	4	2	3	Bar

W63 AL/HAL (AIR-TO-LOWER) - STANDARD STROKE

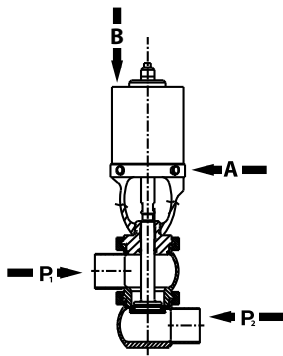

VALVE SIZE	ACTUATOR SIZE									
	PORT (P ₁), ACTUATOR SPRING HOLDS CLOSED AGAINST:									
	4AL	4HAL	5AL	5HAL	6AL	6HAL	A2	B2	C2	
1.0" 25mm	231 16	301 21	349 24	--	442 30	--	--	--	--	PSI Bar
1.5" 38mm	164 11	233 16	290 20	497 34	385 27	--	161 11	386 27	--	PSI Bar
2.0" 50mm	81 6	114 8	142 10	244 17	189 13	323 22	59 4	174 12	403 28	PSI Bar
2.5" 63mm	49 3	69 5	86 6	147 10	114 8	195 13	35 2	105 7	243 17	PSI Bar
3.0" 76mm	33 2	46 3	58 4	99 7	77 5	131 9	24 2	71 5	164 11	PSI Bar
4.0" 101mm	17 1	24 2	31 2	52 4	41 3	68 5	--	--	--	PSI Bar

VALVE SIZE	ACTUATOR SIZE									
	PORT (P ₂), AIR TO PORT B, WILL OPEN AGAINST:									
	4AL 50PSI/ 3BAR	4HAL 75PSI/ 5BAR	5AL 50PSI/ 3BAR	5HAL 75PSI/ 5BAR	6AL 50PSI/ 3BAR	6HAL 75PSI/ 5BAR	A2 50PSI/ 3BAR	B2 50PSI/ 3BAR	C2 50PSI/ 3BAR	
1.0" 25mm	154 11	265 18	257 18	319 22	420 29	--	--	--	--	PSI Bar
1.5" 38mm	204 14	316 22	300 21	404 28	462 32	--	--	--	--	PSI Bar
2.0" 50mm	115 8	178 12	169 12	227 16	260 18	356 25	--	--	--	PSI Bar
2.5" 63mm	73 5	114 8	108 7	145 10	166 11	227 16	--	--	--	PSI Bar
3.0" 76mm	51 4	79 5	75 5	101 7	115 8	158 11	--	--	--	PSI Bar
4.0" 101mm	30 2	45 3	43 3	59 4	66 5	92 6	--	--	--	PSI Bar

W63 AL (AIR-TO-LOWER) - LONG STROKE

VALVE SIZE	ACTUATOR SIZE				
	PORT (P ₁), ACTUATOR SPRING HOLDS CLOSED AGAINST:		PORT (P ₂), AIR TO PORT B, WILL OPEN STEM AGAINST:		
	4ALLG	6ALLG	4ALLG	6ALLG	
2.5" 63mm	36 2	123 8	85 6	158 11	PSI Bar
3.0" 76mm	24 2	83 6	59 4	110 8	PSI Bar
4.0" 101mm	13 1	45 3	33 2	62 4	PSI Bar

W65 Holding Pressure Charts

- If pressure rating is higher than documented in tables consult factory before exceeding.
- Minimum air supply requirements: 50 PSI for 4, 5 and 6 inch standard spring actuators; 75 PSI for 4, 5 and 6 inch heavy spring and 4 and 6 inch long stroke actuators; 87 PSI for A, B and C size actuators.
- Please contact the factory for holding pressure values not listed.

W65 AR/HAR (AIR-TO-RAISE) - STANDARD STROKE

VALVE SIZE	ACTUATOR SIZE									
	BOTTOM PORT (P ₁), ACTUATOR SPRING HOLDS CLOSED AGAINST:									
	4AR	4HAR	5AR	5HAR	6AR	6HAR	A1	B1	C1	
1.0"	214	284	336	--	--	--	120	338	801	PSI
25mm	15	20	23	--	--	--	8	23	55	Bar
1.5"	162	230	289	495	418	--	120	338	801	PSI
38mm	11	16	20	34	29	--	8	23	55	Bar
2.0"	76	109	139	237	200	367	62	176	416	PSI
50mm	5	8	10	16	14	25	4	12	29	Bar
2.5"	50	70	87	150	126	239	39	109	258	PSI
63mm	3	5	6	10	9	16	3	8	18	Bar
3.0"	34	47	59	101	85	161	26	75	177	PSI
76mm	2	3	4	7	6	11	2	5	12	Bar
4.0"	19	26	32	56	46	89	15	42	98	PSI
101mm	1	2	2	4	3	6	1	3	7	Bar

VALVE SIZE	ACTUATOR SIZE									
	PORT (P ₂), STEM RAISED, SPRING LOWERS STEM AGAINST:									
	4AR	4HAR	5AR	5HAR	6AR	6HAR	A1	B1	C1	
1.0"	344	418	--	--	--	--	65	272	801	PSI
25mm	24	29	--	--	--	--	4	19	55	Bar
1.5"	344	418	433	--	--	--	65	272	801	PSI
38mm	24	29	30	--	--	--	4	19	55	Bar
2.0"	169	205	218	392	279	--	34	141	416	PSI
50mm	12	14	15	27	19	--	2	10	29	Bar
2.5"	102	124	132	237	168	404	21	88	258	PSI
63mm	7	9	9	16	12	28	1	6	18	Bar
3.0"	69	83	89	160	114	274	14	60	177	PSI
76mm	5	6	6	11	8	19	1	4	12	Bar
4.0"	37	45	49	89	63	152	8	33	98	PSI
101mm	3	3	3	6	4	10	1	2	7	Bar

VALVE SIZE	ACTUATOR SIZE									
	PORT (P ₂), AIR TO PORT A, WILL RAISE STEM AGAINST:									
	4AR 50PSI/ 3BAR	4HAR 75PSI/ 5BAR	5AR 50PSI/ 3BAR	5HAR 75PSI/ 5BAR	6AR 50PSI/ 3BAR	6HAR 75PSI/ 5BAR	A1 50PSI/ 3BAR	B1 50PSI/ 3BAR	C1 50PSI/ 3BAR	
1.0"	223	371	356	--	--	--	36	66	157	PSI
25mm	15	26	25	--	--	--	2	5	11	Bar
1.5"	275	425	403	--	--	--	36	66	157	PSI
38mm	19	29	28	--	--	--	2	5	11	Bar
2.0"	138	212	200	272	285	361	19	34	81	PSI
50mm	10	15	14	19	20	25	1	2	6	Bar
2.5"	79	124	117	157	167	200	12	21	51	PSI
63mm	5	9	8	11	12	14	1	1	3	Bar
3.0"	53	83	79	106	113	135	8	15	35	PSI
76mm	4	6	5	7	8	9	1	1	2	Bar
4.0"	29	45	43	57	61	73	4	8	19	PSI
101mm	2	3	3	4	4	5	0	1	1	Bar

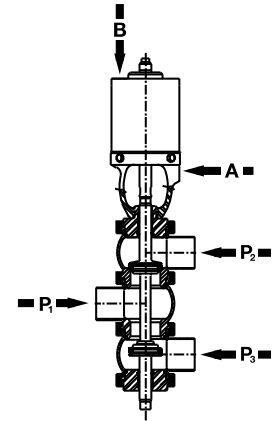

W65 AR/HAR (AIR-TO-RAISE) - STANDARD STROKE (CONTINUED)

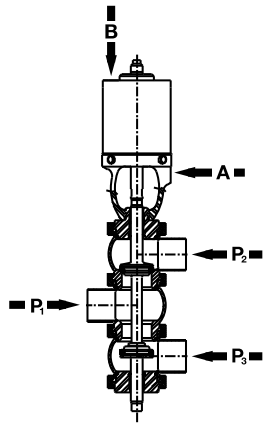

VALVE SIZE	ACTUATOR SIZE									PSI Bar
	PORT (P ₁), AIR TO PORT A, (WITH STEM RAISED), WILL HOLD AGAINST:									
	4AR 50PSI/ 3BAR	4HAR 75PSI/ 5BAR	5AR 50PSI/ 3BAR	5HAR 75PSI/ 5BAR	6AR 50PSI/ 3BAR	6HAR 75PSI/ 5BAR	A1 50PSI/ 3BAR	B1 50PSI/ 3BAR	C1 50PSI/ 3BAR	
1.0" 25mm	93 6	238 16	241 17	228 16	416 29	102 7	68 5	76 5	106 7	PSI Bar
1.5" 38mm	113 8	258 18	259 18	263 18	433 30	167 12	68 5	76 5	106 7	PSI Bar
2.0" 50mm	48 3	119 8	120 8	116 8	206 14	58 4	35 2	40 3	55 4	PSI Bar
2.5" 63mm	29 2	72 5	73 5	70 5	125 9	35 2	22 2	25 2	34 2	PSI Bar
3.0" 76mm	19 1	48 3	48 3	46 3	83 6	22 2	15 1	17 1	23 2	PSI Bar
4.0" 101mm	10 1	25 2	26 2	24 2	45 3	10 1	8 1	9 1	13 1	PSI Bar

W65 AR (AIR-TO-RAISE) - LONG STROKE

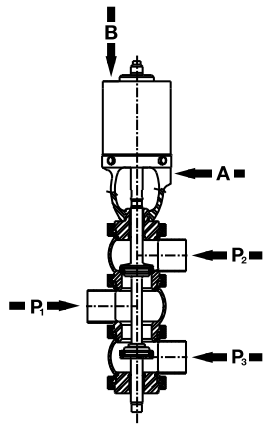

VALVE SIZE	ACTUATOR SIZE								PSI Bar
	PORT (P ₁), ACTUATOR SPRING HOLDS CLOSED AGAINST:		PORT (P ₁), (STEM RAISED) SPRING LOWERS STEM AGAINST:		PORT (P ₁), AIR TO PORT A, WILL RAISE STEM AGAINST:		PORT (P ₁), (WITH STEM RAISED) WILL HOLD AGAINST:		
	4ARLG	6ARLG	4ARLG	6ARLG	4ARLG	6ARLG	4ARLG	6ARLG	
2.5" 64mm	36 2	123 8	53 4	147 10	93 6	170 12	76 5	146 10	PSI Bar
3.0" 76mm	24 2	83 6	39 3	103 7	63 4	114 8	48 3	94 6	PSI Bar
4.0" 102mm	13 1	45 3	21 1	60 4	34 2	62 4	26 2	48 3	PSI Bar
6.0" 152mm	--	19 1	--	26 2	--	24 2	--	18 1	PSI Bar

W65 AL (AIR-TO-LOWER) - LONG STROKE

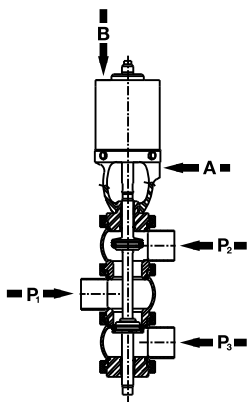

VALVE SIZE	ACTUATOR SIZE								PSI Bar
	PORT (P ₁), AIR TO PORT B, WILL HOLD CLOSED AGAINST:		PORT (P ₁), (STEM RAISED) SPRING HOLDS CLOSED AGAINST:		PORT (P ₁), AIR TO PORT B, WILL LOWER STEM AGAINST:		PORT (P ₁), STEM LOWERED, ACTUATOR SPRING RAISES STEM AGAINST:		
	4ALLG	6ALLG	4ALLG	6ALLG	4ALLG	6ALLG	4ALLG	6ALLG	
2.5" 64mm	76 5	149 10	36 2	123 8	93 6	173 12	53 4	147 10	PSI Bar
3.0" 76mm	48 3	97 7	24 2	83 6	63 4	117 8	39 3	103 7	PSI Bar
4.0" 102mm	24 2	49 3	13 1	45 3	34 2	64 4	24 2	60 4	PSI Bar
6.0" 152mm	--	18 1	--	19 1	--	24 2	--	26 2	PSI Bar

W65 AL/HAL (AIR-TO-LOWER) - STANDARD STROKE

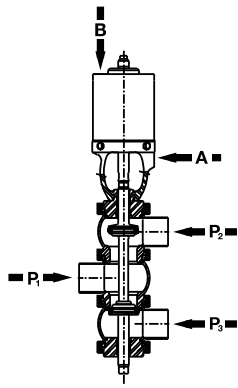

VALVE SIZE	ACTUATOR SIZE									
	PORT (P ₁), AIR TO PORT B, WILL HOLD CLOSED AGAINST:									
	4 AL 50PSI/ 3BAR	4 HAL 75PSI/ 5BAR	5 AL 50PSI/ 3BAR	5 HAL 75PSI/ 5BAR	6 AL 50PSI/ 3BAR	6 HAL 75PSI/ 5BAR	A2 50PSI/ 3BAR	B2 50PSI/ 3BAR	C2 50PSI/ 3BAR	
1.0" 25mm	149 10	295 20	292 20	327 23	--	--	49 3	74 5	164 11	PSI Bar
1.5" 38mm	96 7	241 17	245 17	237 16	--	267 18	49 3	74 5	164 11	PSI Bar
2.0" 50mm	44 3	115 8	117 8	110 8	226 16	120 8	25 2	38 3	85 6	PSI Bar
2.5" 63mm	31 2	73 5	74 5	74 5	140 10	86 6	16 1	24 2	53 4	PSI Bar
3.0" 76mm	21 1	50 3	50 3	50 3	94 6	59 4	11 1	16 1	36 2	PSI Bar
4.0" 101mm	12 1	27 2	28 2	28 2	52 4	33 2	6 0	9 1	20 1	PSI Bar

VALVE SIZE	ACTUATOR SIZE									
	PORT (P ₁), (STEM RAISED), SPRING HOLDS CLOSED AGAINST:									
	4 AL	4 HAL	5 AL	5 HAL	6 AL	6 HAL	A2	B2	C2	
1.0" 25mm	158 11	227 16	285 20	--	380 26	--	113 8	323 22	776 53	PSI Bar
1.5" 38mm	178 12	248 17	300 21	--	397 27	--	113 8	323 22	776 53	PSI Bar
2.0" 50mm	80 6	114 8	142 10	243 17	188 13	322 22	59 4	168 12	403 28	PSI Bar
2.5" 63mm	49 3	69 5	86 6	147 10	114 8	196 14	37 3	104 7	250 17	PSI Bar
3.0" 76mm	32 2	46 3	57 4	98 7	76 5	129 9	25 2	71 5	171 12	PSI Bar
4.0" 101mm	17 1	24 2	31 2	52 4	41 3	68 5	14 1	40 3	95 7	PSI Bar

W65 AL/HAL (AIR-TO-LOWER) - STANDARD STROKE (CONTINUED)

VALVE SIZE	ACTUATOR SIZE									
	BOTTOM PORT (P ₂), AIR TO PORT B, (WITH STEM RAISED), WILL CLOSE STEM AGAINST:									
	4AL 50PSI/ 3BAR	4HAL 75PSI/ 5BAR	5AL 50PSI/ 3BAR	5HAL 75PSI/ 5BAR	6AL 50PSI/ 3BAR	6HAL 75PSI/ 5BAR	A2 50PSI/ 3BAR	B2 50PSI/ 3BAR	C2 50PSI/ 3BAR	
1.0"	278	428	407	--	--	--	13	27	180	PSI
25mm	19	30	28	--	--	--	1	2	12	Bar
1.5"	258	408	389	--	--	--	13	27	180	PSI
38mm	18	28	27	--	--	--	1	2	12	Bar
2.0"	134	207	197	265	300	415	7	14	93	PSI
50mm	9	14	14	18	21	29	0	1	6	Bar
2.5"	81	125	119	160	182	249	4	9	58	PSI
63mm	6	9	8	11	13	17	0	1	4	Bar
3.0"	55	85	81	109	124	171	3	6	40	PSI
76mm	4	6	6	8	9	12	0	0	3	Bar
4.0"	31	47	45	61	68	95	2	3	22	PSI
101mm	2	3	3	4	5	7	0	0	2	Bar

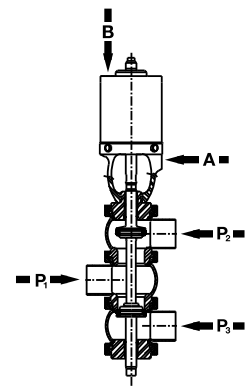

VALVE SIZE	ACTUATOR SIZE									
	PORT (P ₃), (STEM RAISED), ACTUATOR SPRING HOLDS AGAINST:									
	4AL	4HAL	5AL	5HAL	6AL	6HAL	A2	B2	C2	
1.0"	288	360	400	--	--	--	110	320	788	PSI
25mm	20	25	28	--	--	--	8	22	54	Bar
1.5"	302	414	446	--	--	--	110	320	788	PSI
38mm	21	29	31	--	--	--	8	22	54	Bar
2.0"	170	206	222	398	265	--	57	166	409	PSI
50mm	12	14	15	27	18	--	4	11	28	Bar
2.5"	99	120	130	233	157	359	35	103	254	PSI
63mm	7	8	9	16	11	25	2	7	18	Bar
3.0"	66	81	87	157	105	241	24	71	174	PSI
76mm	5	6	6	11	7	17	2	5	12	Bar
4.0"	36	44	48	85	57	131	14	39	97	PSI
101mm	2	3	3	6	4	9	1	3	7	Bar

Air Assist Charts

- 1 Refer to W61 & W65 holding pressure charts for spring only holding force.
- 2 Refer to W62 & W63 holding pressure charts for spring only holding force.
- 3 Air requirements: 50 PSI to actuate 4", 5", & 6" Actuators 75 PSI to actuate 4", 5" & 6" heavy spring and 4" & 5" long stroke actutators; 87 PSI for A, B, and C size actuators (refer to holding pressure charts for holding power).

AIR BOOST FOR PORT B

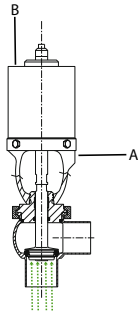

PRODUCT PRESSURE APPLIED TO BOTTOM OF PLUG.

ACTUATOR SIZE	PRODUCT RATIO PER VALVE SIZE						
	1" (25MM)	1.5" (36MM)	2" (59MM)	2.5" (64MM)	3" (76MM)	4" (102MM)	6" (152MM)
"4" (102mm)	6.50	6.50	3.70	2.40	1.60	0.90	--
"5" (127mm)	10.40	10.40	5.80	3.70	2.60	1.50	--
"6" (152mm)	15.00	15.00	8.40	5.40	3.70	2.10	0.95
Y-BODY*	--	--	--	2.20	1.70	0.93	--
"A" Size (74mm)	3.50	3.50	2.00	1.30	0.90	0.50	--
"B" Size (110mm)	8.10	8.10	4.50	2.90	2.00	1.10	--
"C" Size (165mm)	18.60	18.60	10.40	6.70	4.60	2.60	--

Note: * Y Body Valve is only available with 6ARY and 6ALY actuators

Chart shows additional product holding pressure per 1 PSI or BAR of air applied to port B to:

- (1) air assist spring holding force¹ (spring to close)
- (2) calculate holding power on air to air actuator
- (3) calculate additional holding power above the nominal air requirement of the actuator³
- (4) Maximum Air Assist Pressures should not exceed:
 - 70 psi on 4", 5", 6" Maintainable Actuators
 - 15 psi on A, B or C sized Maintenance Free Actuator
- (5) Air Assist pressures should be air regulated to the lowerest required amount of air pressure

AIR BOOST FOR PORT A

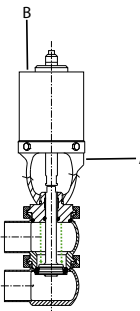

ACTUATOR SIZE	PRODUCT RATIO PER VALVE SIZE						
	1" (25MM)	1.5" (36MM)	2" (59MM)	2.5" (64MM)	3" (76MM)	4" (102MM)	6" (152MM)
"4" (102mm)	6.50	6.50	3.70	2.40	1.60	0.90	--
"5" (127mm)	10.40	10.40	5.80	3.70	2.60	1.50	--
"6" (152mm)	15.00	15.00	8.40	5.40	3.70	2.10	0.95
Y-BODY*	--	--	--	2.20	1.70	0.93	--
"A" Size (74mm)	4.70	4.70	2.30	1.40	0.90	0.50	--
"B" Size (110mm)	10.80	10.80	5.30	3.20	2.20	1.20	--
"C" Size (165mm)	24.80	24.80	12.10	7.30	4.90	2.70	--

Chart shows additional product holding pressure per 1 PSI or BAR of air applied to port A to:

- (1) air assist spring holding force¹ (spring to close)
- (2) calculate holding power on air to air actuator
- (3) calculate additional holding power above the nominal air requirement of the actuator³
- (4) Maximum Air Assist Pressures should not exceed:
 - 70 psi on 4", 5", 6" Maintainable Actuators
 - 15 psi on A, B or C sized Maintenance Free Actuator
- (5) Air Assist pressures should be air regulated to the lowerest required amount of air pressure

Example:

W61T-3" with 5" Air to Raise (Spring to Close) actuator required to hold against 75 PSI product pressure.

Holding pressure required: 75 PSI

Minus Spring only holding force: - 55 PSI

(From page 16)

Additional holding power required: 20 PSI _____

$$\text{Air Assist pressure required} = \frac{\text{Additional holding power required}}{\text{Product Ratio from chart above}} = \frac{20}{2.6}$$

7.79 PSI
Air Required to Port B

W60 Series Valves: Safe, Strong and Sanitary

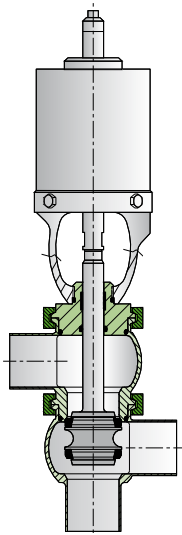

W62TT

Cleanable, Designed For Sanitary / Hygienic Applications

- 316L Stainless Steel wetted parts
- Minimal internal crevices and high surface finishes
- Free-spinning, snap-on TFM or PEEK seats for reliable sealing: choice of Tef-Flow, Tef-Flow P, tri-ring, or metal
- Captive, supported stationary seals located forward to the product zone: choice of o-ring, quad, or wiping stem seals
- Free draining in multiple positions – including upside down
- 3-A compliant, FDA approved materials

Heavy-duty Construction

- Machined-from-bar body construction can withstand mishandlings of active plant environment & lead to long service life
- Consistently thick body wall dimensions & laser welded port extensions minimize body distortion during manifolding & extreme fluid temperature changes
- Deep, inter-locking bodies and adapters
- Heavy-Duty Clamps & High Pressure Adapters for up to 1220 PSI applications
- Multiple split TFM bearing support of stems

Flexibility & Modularity

- Major components (body, stem, adapter, actuators) are modular in design to quickly and easily assemble or retrofit in field a valve to meet specific applications
- Choice of standard fully maintainable actuator or cost-effective maintenance-free actuator with 5-year warranty with various sizes and spring options
- True-line mix body sizes and custom 45° or other angled ports available to match complicated pipe design
- One-piece bodies or two-piece clamped
- AL6XN alloy product zone parts available for corrosive products
- Custom port lengths and center-to-center dimensions can match competitor and legacy series valves to provide easy drop-in replacements
- Various control top models available to fit customer needs: cost-effective CU4 full-featured, robust WCB control tops, or state-of-the-art Burkert 8681



Heavy-duty Construction

Low Cost of Ownership

- Heavy-duty construction maximizes service life
- Minimum proprietary parts gives off-the-shelf availability and low price of most spares and components
- Available spare parts from local distributor or factory in Delavan, WI
- Modular design enables multi-use parts, easy training & familiarity with whole family of valves, minimum spares required on shelf
- Long life standard actuator is field-maintainable with finger-safe, caged springs and cartridge piston assemblies
- Commonality of parts: same part numbers used multiple places
- Simple, easy-to-maintain design is intuitive and does not require advanced mechanical skills

Domestic Manufacture, Local Support

- Value-Added Distributor Relationships
- Face-to-Face Representation
- Manufacturing, Assembly, Inventory, Engineering & Customer Service in Delavan, Wisconsin, USA



Valve Adapter Options

The 'standard' adapter is used on all models of short and long stroke W60 Series valves. Machined from 316LSS bar with a thick cross-section, the adapter adds strength to the valve body and provides alignment for the stem. The outer perimeter seals to the valve body with an O-ring that is located forward to the product zone to minimize crevices. The product stem passes through the adapter and is sealed to the adapter with an O-ring. A TFM split bearing guides the stem and takes up the mechanical loading imparted by hydraulic forces. This increases the service life of the stem seal. Adapters are made in 1"-6" (25mm -152mm) sizes.

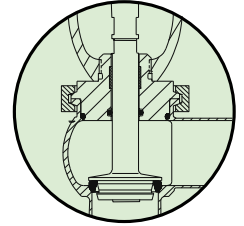

The pressure limitation of the W60 adapter is the sealing capability of the dynamic O-ring on the product stem. This variation of the W60 adapter uses a backing ring added on the atmospheric side to support the stem O-ring. This significantly boosts the pressure rating on the stem O-ring. The product stem passes through the adapter and is sealed to the adapter with an O-ring and is guided by a TFM split bearing.

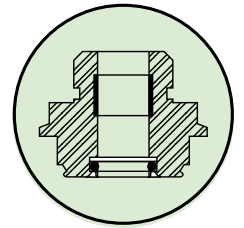

This adapter is used to convert a 'standard' W60 series valve to a W80. The outer perimeter seals to the valve body with an O-ring that is located forward to the product zone to minimize crevices. The product stem passes through the adapter and is sealed in the upper part and the lower part of the adapter with O-rings. The space between the O-rings is flushed with a suitable liquid or steam. The TFM split bearing is located in the flushed chamber. Adapters are made in 1"-6" (25mm - 152mm) sizes. For vacuum-rated, extended shelf-life (ESL) applications, the W80A adapter adds steam trace to the adapter-to-valve body connection.

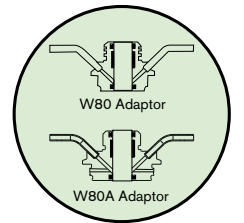

For high-risk and hard to clean product applications, the wiping stem seal fills the gap between the product zone and the traditional O-ring stem seal. The adapter is a two-piece design to allow easy inspection or replacement of the wiping stem seal. The outer perimeter seals to the valve body with an O-ring that is located forward to the product zone to minimize crevices. A TFM split bearing is used to guide and support the valve stem.

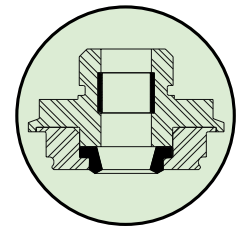

W60/W80 Series

SHUT OFF AND DIVERT VALVES

SPXFLOW

Based in Charlotte, North Carolina, SPX FLOW, Inc. (NYSE: FLOW) is a multi-industry manufacturing leader. For more information, please visit www.spxflow.com

SPX FLOW

611 Sugar Creek Road

Delavan, WI 53115

P: (262) 728-1900 or (800) 252-5200

E: leads@spxflowleads.com

SPX FLOW, Inc. reserves the right to incorporate our latest design and material changes without notice or obligation.

Design features, materials of construction, dimensional data and certifications as described in this bulletin, are provided for your information only and should not be relied upon unless confirmed in writing. Please contact your local sales representative for product availability in your region. For more information visit www.spxflow.com.

The green "y" and "x" are trademarks of SPX FLOW, Inc.

WCB_Valves-Single-Seat-DS-1201_DST_US Version: 01/2021

Identification Number: DS-1201-US

COPYRIGHT © 2021 SPX FLOW, Inc.