

453251 ISS T 10.08

NOTE: _____

Speed: $n=1450^{-1}$ 50 Hz
 Impeller: Max. dia 220 mm
 Min. dia 160 mm
 Pump inlet: 76 mm
 Pump outlet: 51 mm

Performance data refer to water at 20°C
 Permissible tolerance $\pm 5\%$

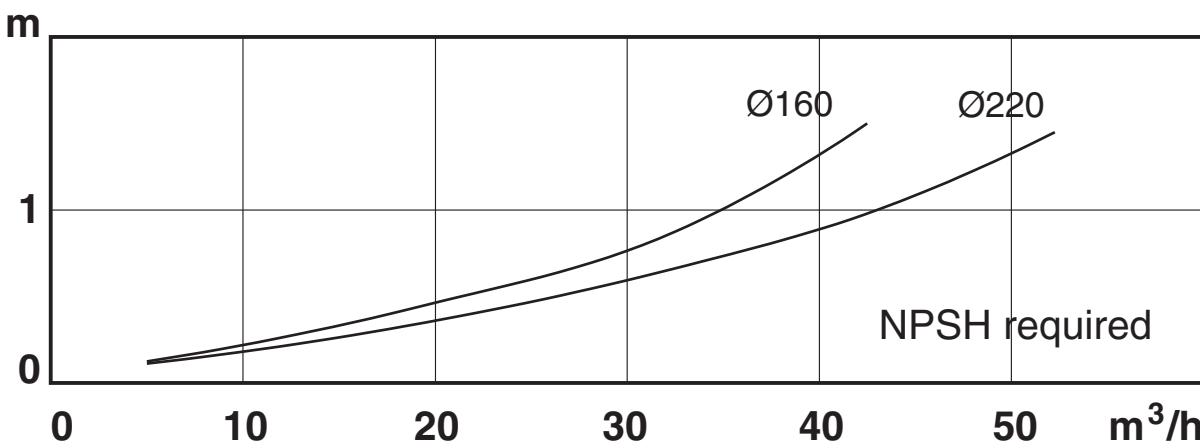
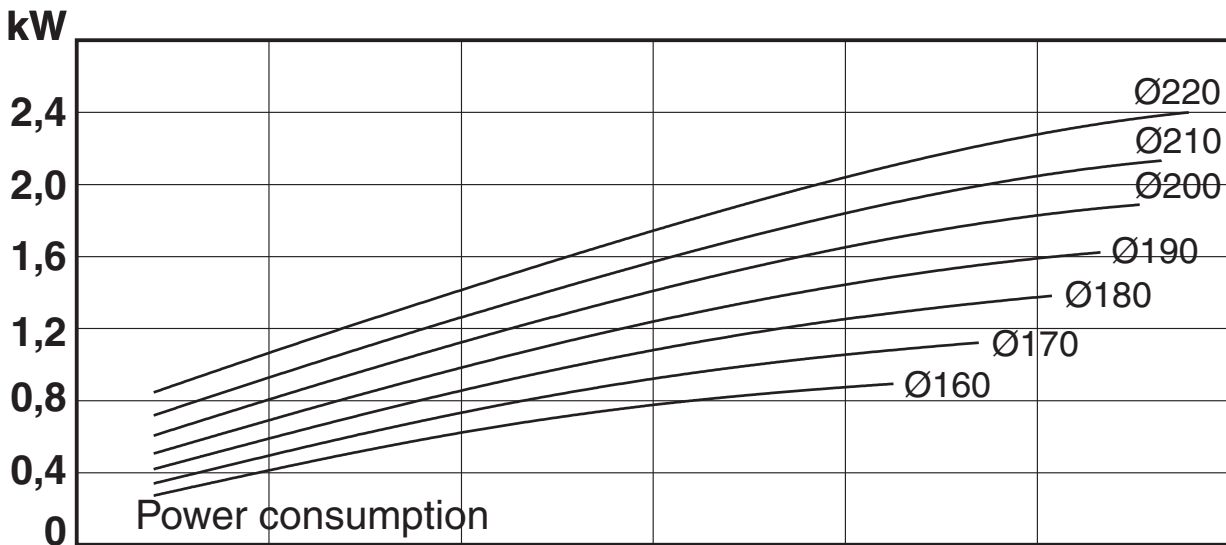
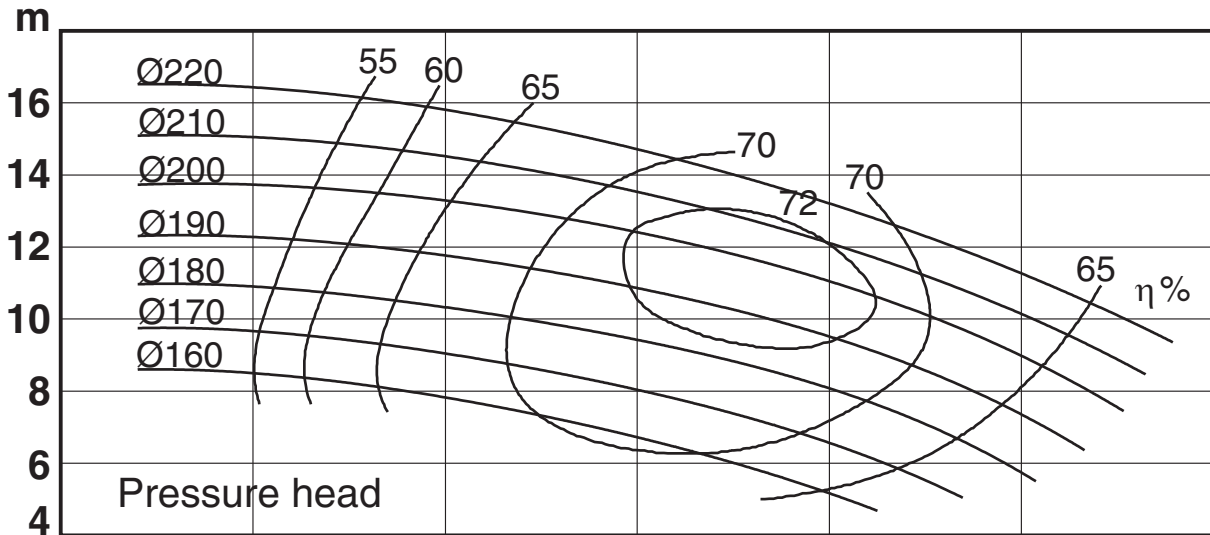

453251 ISS T 10.08

NOTE: _____

Speed: $n=2900^{-1}$ 50 Hz
 Impeller: Max. dia 220 mm
 Min. dia 160 mm
 Pump inlet: 76 mm
 Pump outlet: 51 mm

Performance data refer to water at 20°C
 Permissible tolerance $\pm 5\%$

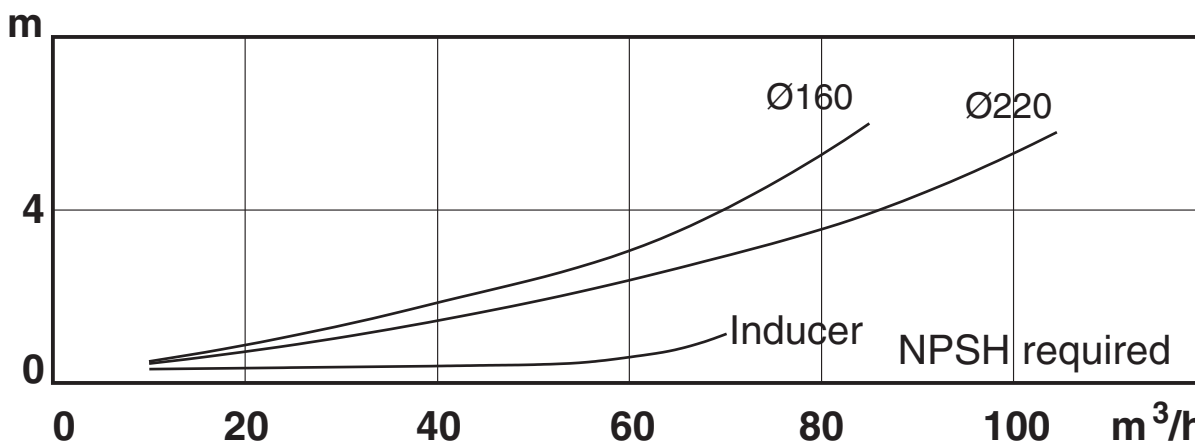
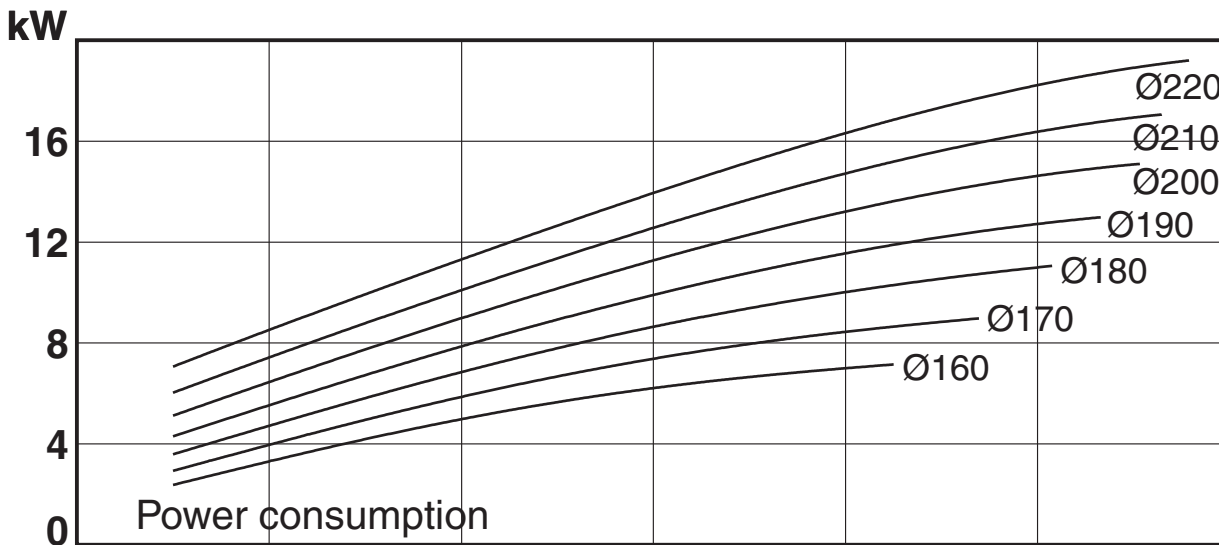
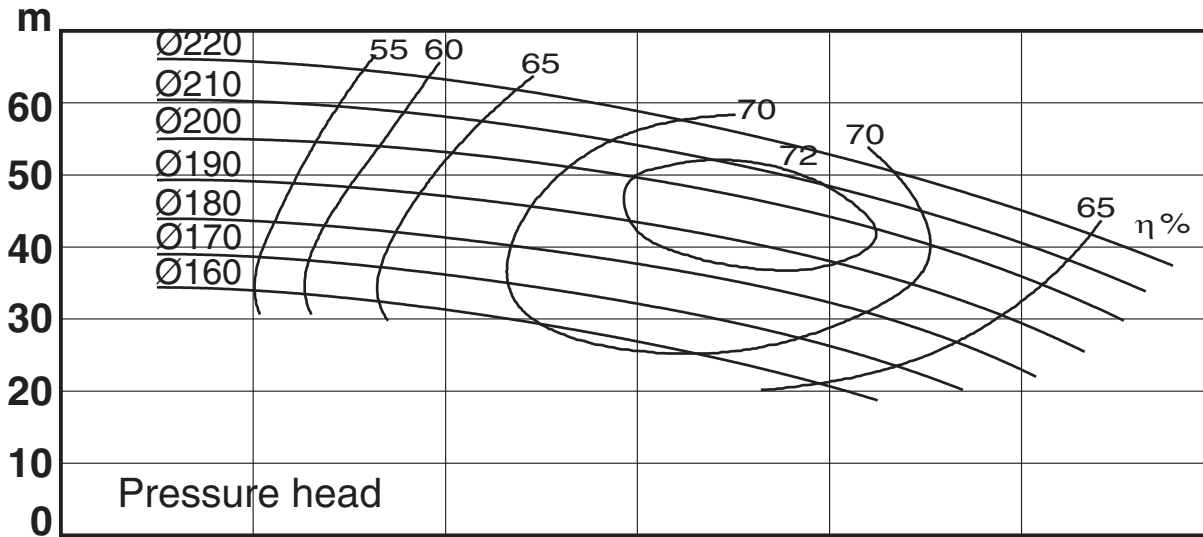

453251 ISS T 10.08

NOTE: _____

Speed: $n=1750^{-1}$ 60 Hz
 Impeller: Max. dia 220 mm
 Min. dia 160 mm
 Pump inlet: 76 mm
 Pump outlet: 51 mm

Performance data refer to water at 20°C
 Permissible tolerance $\pm 5\%$

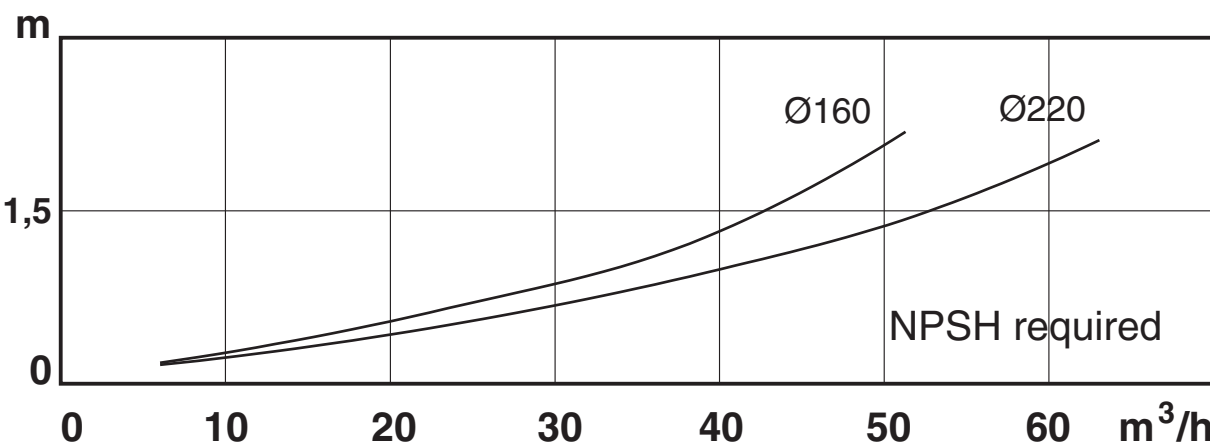
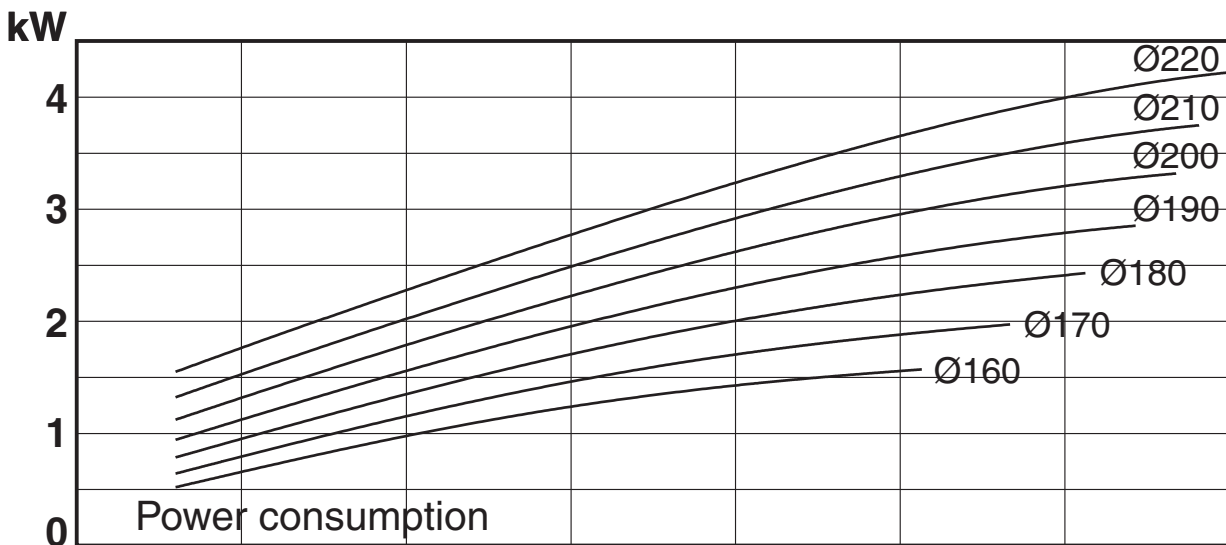
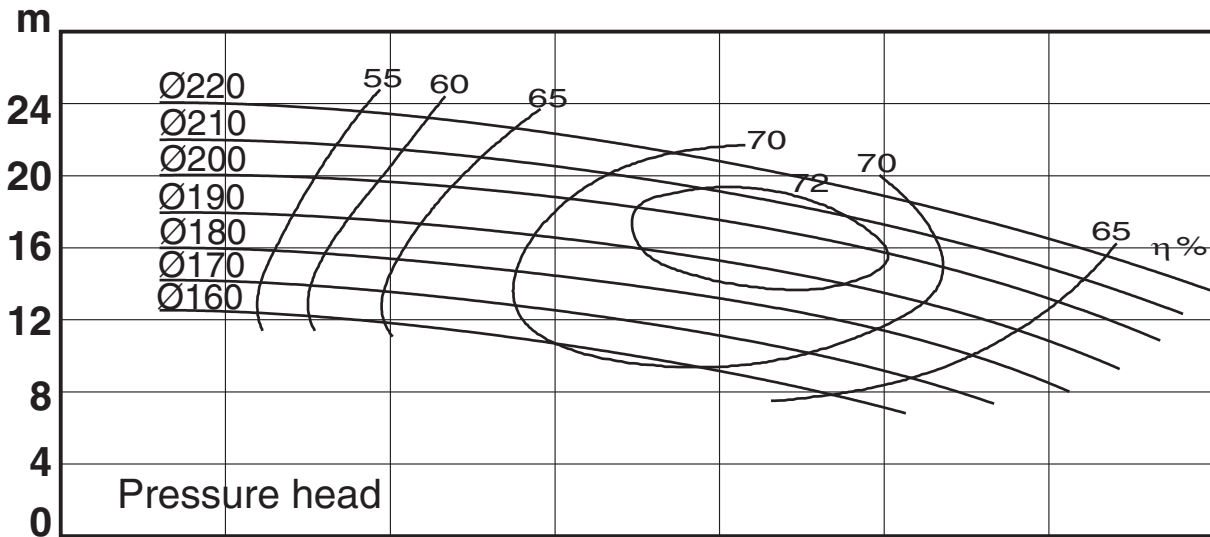

453251 ISS T 10.08

NOTE: _____

Speed: $n=3500^{-1}$ 60 Hz
 Impeller: Max. dia 220 mm
 Min. dia 160 mm
 Pump inlet: 76 mm
 Pump outlet: 51 mm

Performance data refer to water at 20°C
 Permissible tolerance $\pm 5\%$

