



# RANNIE® 77T GAULIN® 77T

High Pressure Homogeniser



SPXFLOW®

# DESIGNED TO ENHANCE YOUR PRODUCTIVITY



**Delivering powerful  
performance and  
increased productivity**



## **Performance under pressure**

The APV® 77T homogeniser is a three-plunger reciprocating pump, fitted with hydraulically actuated homogenising valves.

The APV 77T incorporates a durable slow-speed power end in a low and compact design, for optimal performance and reliability.

One point of control and direct visibility to all internal and external indicators, combined with easy access to all service areas, saves time and money by simplifying inspection and reducing maintenance to a minimum.

## **Enhanced APV® Rannie® and Gaulin® 77T Homogeniser**

The modular and flexible design of the APV 77T makes it suitable for a wide range of applications in dairy, food, beverage, industrial and pharmaceutical industries. Homogenising valves can easily be changed to accommodate different types of product and/or capacities on the same homogeniser.

Liquid end options include the Rannie three-piece valve housing and the Gaulin mono-block design, both available with a choice of valves, plungers and packings according to your requirements.

These design simplify routine maintenance with emphasis on reliability and sturdiness in order to reduce total costs of ownership.



# ENHANCED OPERATING BENEFITS

## Optimal operator interface

- Operator controls and gauges all in one location
- Gauges and other visual indicators are visible from the operating position
- Direct view of key power and check points through a window
- Modular electrical controls

## High reliability

- Internal gear transmission
- Enhanced oil treatment and cooling system with oil filter as standard
- Low centre of gravity for reduced vibration
- Balanced low-speed crankshaft for reduced noise

## Maintenance friendly design

- Easy access for servicing, reduced maintenance time
- Low machine height for ergonomic access
- Visual service indicators
- Improved cooling and oil treatment indicators
- Access to electric control box from the outside
- Built-in belt tensioner

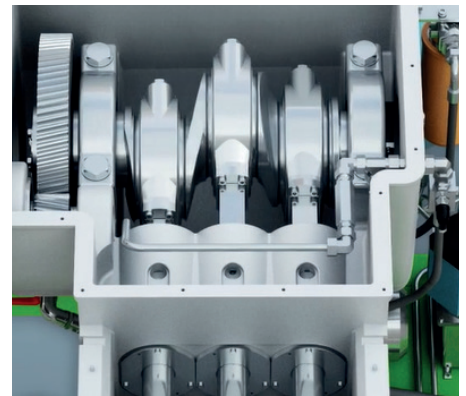
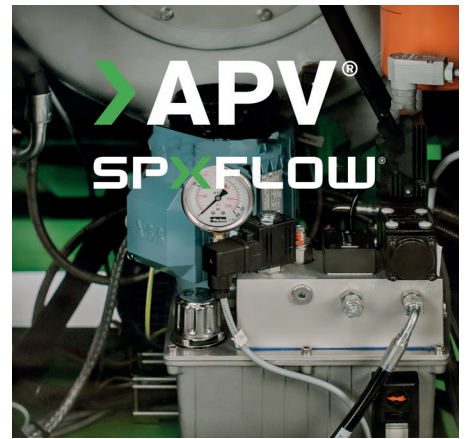

# FEATURES AND APPLICATIONS



More features as standard and a range of options creating solutions that fit your needs



## The liquid end includes

- Pressure gauges
- Pressure relief valve
- Weld-stub product connections
- 3-A sanitary design in stainless steel or duplex materials
- Ball or poppet pump valves
- Hard metal coated long life plungers
- Hydraulic valve actuator for smooth and stable control
- Single or two stage homogenising valve, to meet your application requirements

## The power end includes

- Internal gear and self-adjusting belt tightener
- Oil cooling system with external plate heat exchanger and temperature transmitter
- Oil filter including alarm



# Designed to provide powerful performance, simplified maintenance, and smoother operation across a wider range of applications.

## Other standard features

- All equipment wired to stainless steel control cabinet
- Emergency stop
- Stainless steel sanitary cladding
- Inspection window for key operating indicators
- Set of tools
- Set of packings

## Standard options

- Start/stop buttons
- Alternative product connections e.g. tri-clamp, high-pressure outlet, dual inlet
- Automatic hydraulic actuators and 4-20mA gauges for remote operation
- Potentiometer-controlled electrical valves for hydraulic actuators
- Plunger lubrication control package including flow switch and solenoid valve
- Inlet pressure gauge with low pressure switch
- Outlet pressure gauge or transmitter
- Aseptic cylinder design
- Sanitary pulsation dampener(s): inlet and outlet
- Micro-gap valve for increased efficiency and reduced energy consumption
- Motor starter cabinet
- Control cabinet with PLC or relay operation
- Low-noise insulated extension for liquid end
- Ceramic plungers
- Choice of materials for cylinder block, pump valves, homogenizing valves, packings, etc.
- Enhanced spare parts kit

## Other options on request

- Various enhanced liquid end block designs for special applications
- Actuated pressure relief valve
- Vibration sensors
- Explosion-proof design
- Electro-polished wetted parts
- UFO - oil filtration system
- Documentation packages for material traceability, certification and cGMP support

## Key Applications



### Dairy –

Providing extended shelf stability, improved smoothness, body and colour for a wide range of dairy applications including milk, cream, yoghurt and deserts.



### Food –

Delivering improved viscosity, shelf stability, colour or reduce ingredients costs for food and beverage applications including ketchup, eggs and abyfood.



### Cosmetics –

Providing enhanced shelf life stability and ingredient optimization on products such as body creams and lotions.



### Pharmaceutical –

Improves stability and uniformity while achieving narrow particle size distribution and enhanced texture on products such as intravenous emulsions and ointments.



### Industrial –

Benefits include particle size and viscosity control, enhanced colour, uniformity or application and improved stability for chemical and industrial applications such as inks, emulsifiers, lubricants and late.

## RANNIE MODEL 77T / THREE-PIECE VALVE HOUSING POPPET AND BALL VALVES

TYPE	US UNITS		METRIC UNITS	
	CAPACITY GPH	PRESSURE PSI	CAPACITY LPH	PRESSURE BAR
75.95	3,550	2,175	13,500	150
70.95	3,100	2,500	11,800	170
65.95	2,650	3,000	10,000	210
42.95	1,320	5,800	5,000	400
25.95	265	17,400	1,000	1,200
22.95	210	21,750	800	1,500



**Rannie Three-Piece  
Valve Housing**

## GAULIN MODEL 77T / MONO-BLOCK VALVE HOUSING POPPET AND BALL VALVES

TYPE	US UNITS		METRIC UNITS	
	CAPACITY GPH	PRESSURE PSI	CAPACITY LPH	PRESSURE BAR
<b>POPPET TYPE VALVES</b>				
2.1P	3,550	2,175	13,500	150
2.5P	3,100	2,500	11,750	170
3.0P	2,640	3,000	10,000	210
5.8P	1,320	5,900	5,000	400
<b>BALL TYPE VALVES</b>				
2.1B	3,375	2,175	12,750	150
2.5B	2,940	2,500	11,100	170
3.0B	2,640	3,000	10,000	210
5.8B	1,190	5,800	4,500	400

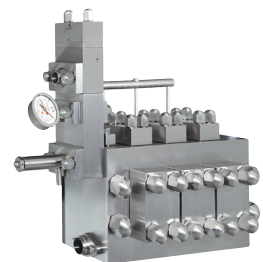

**Gaulin Mono-Block  
Valve Housing**

DIMENSIONS	LENGHT IN / MM	WIDTH IN / MM	HEIGHT IN / MM	WEIGHT (INCL. MOTOR) LBS. / KG
STANDARD MACHINE	89 / 2,260	56.5 / 1,435	56 / 1,425	5,845 / 2,650
PACKED IN CRATE	118 / 3,000	71 / 1,800	71 / 1,800	6,725 / 3,050
STANDARD INCL. LOW NOISE EXTENSION	111 / 2,820	64 / 1,630	66 / 1,680	6,950 / 3,150
CUBIC MEASURE OF STANDARD CRATING: 9,72 M <sup>3</sup>				

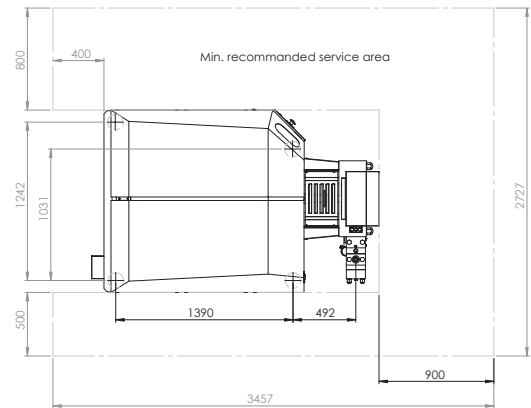
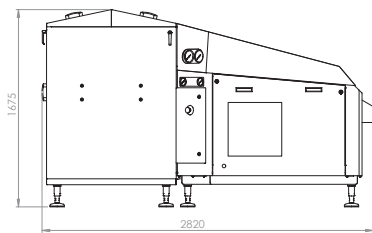
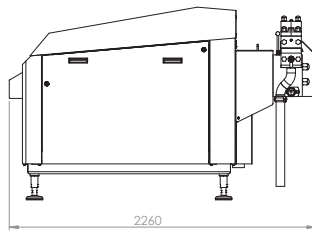
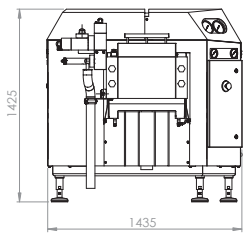

## TECHNICAL SUMMERY

Gross Weight	3,050 kg
Net Weight	2,650 kg
No. of plungers	3

Lubrication Water Flow rate	150 L/hr
Cooling Water Flow rate	150 L/hr
Power End Oil Volume	50 L





SPX FLOW, Inc. reserves the right to incorporate our latest design and material changes without notice or obligation. Design features, materials of construction and dimensional data, and certifications as described in this bulletin, are provided for your information only and should not be relied upon unless confirmed in writing. Please contact your local sales representative for product availability in your region. For more information visit [www.spxflow.com](http://www.spxflow.com).

The green “>” and “x” are trademarks of SPX FLOW, Inc.

APV\_Homogeniser-77T\_APV-3177\_GB Version 01/2024

COPYRIGHT © 2024 SPX FLOW, Inc.