

# TopWing

EXPLOSION PROTECTION ACCORDING TO ATEX (94/9/EC)

A.0501.301 – ATEX IM-TW/05.00 EN (12/2011)

ORIGINAL INSTRUCTIONS

READ AND UNDERSTAND THIS MANUAL PRIOR TO OPERATING OR SERVICING THIS PRODUCT.



# Declaration of conformity

according to EC directive 94/9/EC (ATEX)

## Manufacturer

SPX Flow Technology Sweden AB  
P.O.Box 1436  
SE-701 14 Örebro  
Sweden

Declares hereby that

the following product families, if ordered as ATEX pump or ATEX pump unit, are meeting the requirements set forth in EC directive 94/9/EC of 23 March 1994.

If the product is modified without our written permission, or if the safety instructions in the instruction manuals are not being followed, this declaration becomes invalid.

- Product families: TopWing
- Notified body: SP Sveriges Provnings- och Forskningsinstitut  
P.O. Box 857  
SE-501 15 Borås  
Sweden
- Tech. File Ref.: JP 03-13346-01/040614
- Standards: Applicable harmonised standards  
EN 13463-1  
EN 13463-5
- Marking: The marking includes the  symbol and the technical file reference.  
Special conditions for safe use are specified in the Ex-Instruction Manual.

Örebro, Sweden, 1 January 2010



Michael Strålman  
Managing Director

# Table of Contents

Disclaimer .....	4
1.0 General .....	5
1.1 Symbol .....	5
1.2 Safety Information.....	5
1.3 Responsibility for ATEX certification – extend of delivery .....	5
1.4 Marking .....	6
1.5 ATEX type designation examples.....	7
1.6 Temperature classes and allowable temperatures.....	7
1.6.1 II 2G allowable temperature.....	7
1.6.2 II 2(G)D allowable temperature .....	8
1.7 Responsibility .....	8
1.8 Operation .....	8
1.9 Monitoring .....	9
1.10 Residual risks .....	10
3.0 Installation .....	12
3.1 Checks.....	12
3.2 ATEX certification .....	12
3.3 Working environment.....	12
3.4 Base plate .....	12
3.5 Drive, shaft coupling and protection guard .....	12
3.6 Direction of rotation .....	13
3.7 Piping .....	13
3.8 Shaft sealing auxiliary connections.....	13
3.9 Check alignment.....	13
4.0 Commissioning .....	14
4.1 General .....	14
4.2 Precautions .....	14
5.0 Maintenance .....	15
5.1 General .....	15
5.2 Gearbox .....	15
5.3 Shaft seals.....	15
5.3.1 Quench/Flushing (see IM) .....	15
6.0 Limiting risks by means of “check list” .....	16
6.1 During installation.....	16
6.2 Before starting the pump.....	16
6.3 When starting the pump .....	16
6.4 When the pump is running .....	17
6.5 When stopping the pump.....	17

# TopWing – Operating instructions concerning explosion protection

## **Disclaimer**

Considerable effort has been made to ensure that this manual is free of inaccuracies and omissions. However, even though the manual contains up to date data at time of going to press, due to constant improvements some of the data contained herein may not exactly reflect the current model of the particular product described in this manual.

SPX reserves the right to change the construction and design of the products at any time without being obliged to change previous models accordingly.



**These instructions contain important and useful information on explosion protection in accordance with EU directive 94/9/EC – ATEX.**

**All relevant instructions about installation, operation and maintenance of the pump and the pump unit can be found in the separate pump's "Instruction Manual". These instructions should be adhered to at all times!**

SPX Flow Technology Sweden AB  
P.O.Box 1436  
SE-701 14 Örebro  
Sweden  
Tel. +46 (0)19 21 83 00  
Fax. +46 (0)19 27 23 72

## 1.0 General

### 1.1 Symbol

The following symbol is used to indicate special instructions concerning explosion protection:



### 1.2 Safety Information

This manual covers the main issues concerning explosion protection and must be used together with the general Instruction Manual for TopWing pumps, called hereafter "IM" and the manuals of other equipment such as gear and motor drives.

For explosion protection safety it is imperative that the pump set must be protected from all unauthorised operation and unnecessary wear.

Explosive gas mixtures or concentrations of dust, in conjunction with hot, live and moving parts on pump, gear and motor unit, can lead to severe or fatal personal injuries.

Installation, connection, start-up, maintenance and repair work may only be performed by qualified personnel while taking in account:

- these specific instructions, together with all other instructions for the installed equipment and installation;
- warning and information signs on the equipment;
- the specific regulations and requirements for the system in which the pump unit will operate (current valid national and regional regulations).

### 1.3 Responsibility for ATEX certification – extend of delivery



SPX will be held responsible only for delivered materials and equipment selected according to the operating conditions data, based on information supplied by the customer or the end user and stated in the order confirmation. When in doubt contact your local supplier.

In the event SPX delivers a pump with bare shaft, the explosion protection certification marking on the pump nameplate refers exclusively to the pump part. All other assembled equipment should have separate certification of at least the same or higher grade of protection as the pump, delivered by the supplier(s) of that equipment. The complete unit must be certified separately by the final assembling manufacturer and must have a separate name plate supplied by the pump unit manufacturer.

In the event SPX delivers a complete unit, the explosion protection certification, and marking on the nameplate attached to the base plate or to the pump frame, will refer to that specific unit.



## 1.4 Marking

### Name plate on the pump

<b>SPX</b> TopWing <b>CE</b>		<b>Johnson Pump</b> SPX Flow Technology Sweden AB P.O. Box 1436, SE-701 14 Örebro www.spx.com
Type:	①	
Serial No:	②	
	③	
 	④	

- ① Pump type: example: TW2/0171-40/06-W11-GB21-VVS
- ② Serial No: example: NNNN-xxxxxx  
(NNNN indicates the year of production)
- ③ Ex marking.: example:  II 2G c T3-T4
- ④ Tech. File Ref.: TFR 03-13346-01/040614

### Name plate on the unit (in case of delivery of complete unit by SPX)

<b>SPX</b>	SPX Flow Technology Sweden AB P.O. Box 1436, SE-701 14 Örebro www.spx.com	<b>CE</b>
Type:	①	
Code:		
Serial No:	②	
	③	
 	④	
<b>Johnson Pump</b>		

- ① Type: example: TW2/0171-40/06-W11-GB21-VVS
- ② Serial No: example: NNNN-xxxxxx  
(NNNN indicates the year of production)
- ③ Ex marking.: example:  II 2G c T3-T4
- ④ Tech. File Ref.: TFR 03-13346-01/040614

## 1.5 ATEX type designation examples

### Example 1: Ex II 2G c T3-T4

**II 2G** marking according to Group II, Category 2, Gas (G) protection  
**c** marking essential for safe use ignition protection (c = constructional safe)  
**T3-T4** temperature class T3 to T4

### Example 2: Ex II 2G c 240°C (T2)

**II 2G** marking according to Group II, Category 2, Gas (G) protection  
**c** marking essential for safe use ignition protection (c = constructional safe)  
**240°C** for a maximum surface temperature of 240 centigrade (degrees Celsius)  
**(T2)** corresponding T2 temperature class.

### Exempel 3: Ex II 2D c 240°C

**II 2D** marking according to Group II, Category 2, Dust (D) protection  
**c** marking essential for safe use ignition protection (c = constructional safe)  
**240°C** for a maximum surface temperature of 240 centigrade (degrees Celsius)

Environment temperature should be between -20°C and +40°C, if not, the corresponding environment temperature will be indicated on the nameplate.

## 1.6 Temperature classes and allowable temperatures

In normal operation the highest temperature on the surfaces of the pump will either correspond to the temperature of the pumped liquid marked up with safety margin for a possible spot temperature rise on the mechanical seal, or the temperature on the gear-box oil or the heating medium in case the pump is heated by jackets. The maximum permissible temperature depends on the temperature class (T5 to T3) or on  $T_{max}$  to be complied with. The complete pump surfaces must be freely exposed to the atmosphere to allow proper cooling.

All data (temperature classes) are related to ambient temperature of 20°C and 40°C. If an ambient temperature above 40°C, correction must be made according to the difference. Always contact your local local supplier.

### 1.6.1 II 2G allowable temperature

**EX II 2G cT:** Permissible temperature class related to max shaft speed, power and liquid temperature.

**Remark:** Corrections have been made due to higher surrounding air temperature. The gearbox surface and oil temperature is directly dependent to the surrounding temperature.

		TW4		TW3		TW2		TW1	
	<b>Temperature of pumped fluid °C</b>	20	70	20	70	20	70	20	70
	Mechanical seal "Spot" temp. °C	57*	123*	57*	123*	57*	123*	57*	123*
	Gearbox oil temperature °C	98	106	<135	<135	104	114	<135	<135
<b>Temperature class</b>	<b>Ambient temp. 20° C</b>	<b>T5</b>	<b>T4</b>	<b>T4**</b>	<b>T4**</b>	<b>T4</b>	<b>T4</b>	<b>T4**</b>	<b>T4**</b>
	<b>Ambient temp. 40° C</b>	<b>T4</b>	<b>T4</b>	<b>T3**</b>	<b>T3**</b>	<b>T4</b>	<b>T4</b>	<b>T3**</b>	<b>T3**</b>

\* Correction based on recommendation from seal manufacturer related to highest spot temperature on seal face.

\*\* Judgment based on earlier temp. tests – extra safety margin applied until final tests are performed.

Temperature class EN 13463-1	Spot temperature on primary seal	Temperature $T_{max}$ pumped medium	Max. temperature of gearbox oil	Heating medium $T_{max}$ (if applicable) jackets
T3 – 200°C	<200°C	<=140°C	<=200°C	<=140°C
T4 – 135°C	<135°C	<=88°C	<=135°C	<=88°C
T5 – 100°C	<100°C	<=60°C	<=100°C	<=60°C
T6 – 85°C	<85°C	<=48°C	<=85°C	<=48°C

(\*) Temperature can be adapted to the temperature limits of the selected internal pump sections.  
In the case of limiting, it is preferable to state the permissible maximum temperature ( $T_{max}$ ) on the nameplate in the same way as for dust (D) protection.

## 1.6.2 II 2(G)D allowable temperature

The maximum surface temperature ( $T_{max}$ ) is indicated on the name plate.

$T_{max}$  is determined as the lowest temperature derived from following equations:

- $T_{max}$  = temperature limits of selected internal materials (i.e. pump selection).
- $T_{max} = T_{5mm} - 75^{\circ}\text{C}$  ( $T_{5mm}$  “ignition temperature of a dust layer of 5 mm thickness”)
- $T_{max} = 2/3 \times T_{Cl}$  ( $T_{Cl}$  “ignition temperature of a dust cloud”).

### Remark:

$T_{5mm}$  and  $T_{Cl}$  are to be determined by the customer/user in case of dust (D) protection.  
In case the ambient temperature exceeds the range of  $-20^{\circ}\text{C}$  /  $+40^{\circ}\text{C}$  contact your local supplier.

## 1.7 Responsibility

It is the responsibility of the operator to ensure that specified product temperatures are not exceeded and to ensure regular inspections and maintenance for good operation of the shaft seal and the internal pump parts. If this cannot be ensured by the operator, suitable monitoring facilities must be provided, see 1.9.

## 1.8 Operation

- In case of a mechanical seal arrangement it is imperative that the pump will not run dry. The pump must always be filled completely with, and lubricated by the product to be handled during operation (including start-up, priming and shut-off).
- In case of self-priming operation, the appropriate shaft seal (quenched or flushed) must be selected and controlled with regard to the quench/flushing liquid.
- The pump must never be operated continuously with the safety relief valve opened. The relief valve is designed as a safety device in case of overpressure and may not be used for flow control.
- When flow control is performed by by-passing the return liquid, the liquid must return to the suction tank and not directly to the suction port of the pump, in which case heat accumulation in the pump could create a dangerous situation.
- The pump must never be operated with the shut-off valves in the suction or discharge lines closed.
- The pump can only run dry continuously, equipped with quench or flushing system in operation.



## 1.9 Monitoring

If good function and/or maximum allowable surface temperatures cannot be ensured by regular inspection by the operator, suitable monitoring devices must be provided for.

Surface temperature monitoring is always of extreme importance in the following areas, see figure 1:

- Surface temperature of the pump casing at the front cover (L1).
- In case of quenched/flushed seal arrangement, monitoring can be done by checking the quench/flushing fluid, see 5.3. Use of quenched/flushed seal arrangement is highly recommended when there is any risk of dry running or lubrication failure of the seal such as in case of self priming.
- Surface temperature on the gearbox (L2, L3).

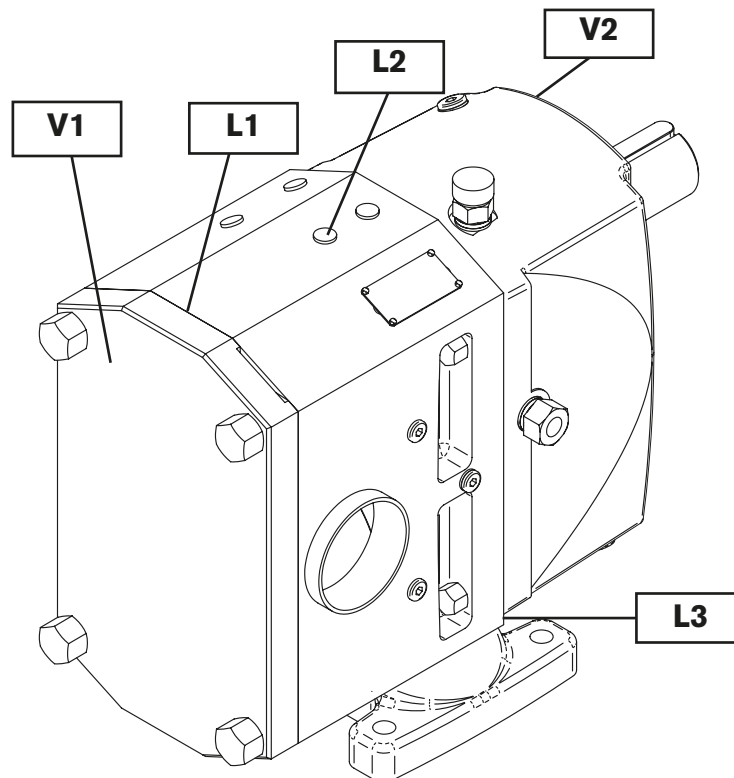

*Fig 1 – Indication of monitoring possibilities and advised locations (optionally)*

Additional vibration monitoring can be useful to detect excessive vibrations, indicating premature failure of ball bearing or internal wear in the following areas:

- areas at the pump front (V1).
- gearbox area (V2).

Always contact your local supplier to get advice regarding positioning of sensors.

## 1.10 Residual risks

(based on the risk analysis according to SS-EN13463-1)

Potential ignition source			Measures applied to prevent the source becoming effective	Ignition protection used
Normal operation	Foreseeable malfunction	Rare malfunction		
Related to hot surfaces of hydraulic end			<p>The customer has to ensure that the temperature of the pump and heating liquid do not exceed the permissible temperature limits.</p> <p>Additionally, the operator has to ensure that the operating limits for speed, flow and pressure are not exceeded.</p>	<p>SS-EN 13463-1 §6.1</p> <p>Instruction Manual + Ex Instruction Manual</p>
Related to hot surfaces of transmission end			<p>The customer has to ensure that the temperature of the pump and heating liquid do not exceed the permissible temperature limits.</p> <p>Transmission surface must be freely exposed and vented – no built in solution without special cooling measures.</p>	<p>SS-EN 13463-1 §6.1 SS-EN 13463-5 §6</p> <p>Instruction Manual + Ex Instruction Manual</p>
	Excessive heat accumulation		<p>Customer has to ensure a minimum flow through the pump to eliminate accumulation of heat due to internal hydraulic and/or mechanical losses.</p> <p>Monitoring surface temperature of the pump casing is a recommendable measure.</p>	<p>SS-EN 13463-1 §6.1</p> <p>Instruction Manual + Ex Instruction Manual</p>
	Excessive heat at shaft sealing of mechanical seal type		<p>Customer has to follow the specific instructions for the mechanical seal type in the instruction manual and /or separate certificate instructions if present.</p> <p>Single or double mechanical seals with flushing or double mechanical seals with quench (barrier) are to be protected by monitoring and/or controlling of the flushing or quench liquid.</p> <p>Seal arrangements without flushing or quench are not allowed to run without completely air evacuated pump casing. Pumped liquid must always surround the seal.</p>	<p>SS-EN 13463-5 §4.4</p> <p>Instruction Manual + Ex Instruction Manual</p>
		Mechanical sparks caused by contact between rotating parts and stationary pump components	<p>Excessive wear of shaft bearings and mechanical-and/or lip-seal must be prevented through adequate scheduled maintenance.</p> <p>Shaft protection cover must always be in function.</p> <p>This is considered to be a rare malfunction and is therefore not considered in the risk assessment for a category 2 pump.</p>	<p>SS-EN 13463-1</p> <p>Instruction Manual + Ex Instruction Manual</p>
		Electrostatic discharges	<p>Customer should provide earth connections or equipotential bridges in case of indirect risks.</p> <p>This is considered to be a rare malfunction and is therefore not considered in the risk assessment for a category 2 pump.</p>	<p>SS-EN 13463-1</p> <p>Instruction Manual + Ex Instruction Manual</p>

### Remarks:

- For category 2, the risks at “normal operation” and those at “foreseeable malfunction” have to be controlled.
- For category 3, the risks at “normal operation” have to be controlled.

## 2.0 Performance

- Operation of the pump outside its specified operating range may severely jeopardize the whole function of the pump and increase the risk of exceeding allowable temperature limits. See IM.
- In order to remove the heat generated by hydraulic and mechanical friction inside the pump, it must be assured that there is always a sufficient minimum flow through the pump. If this cannot be ensured under all possible operating conditions or because the conditions might change over time due to wear, we advise to foresee a suitable temperature monitoring device. (See chapter 1.9)

**Note:** Internally produced friction heat depends of pump speed and of the properties of the pumped media: viscosity, specific heat, lubricating properties etc.

**It is the responsibility of the operator to ensure the pump operates below the allowable temperature limits as stated in 1.6.**



**Dangerous situations can occur in the following events and should be prevented and/or excluded from normal operation and expected operation (group II-category 2) by adequate operation, supervising and maintenance:**

- Heat accumulation can be caused by internal leakage of the liquid from discharge side to suction side of the pump.  
The pump temperature could increase above allowable limit when the pump is operating with the relief valve opened for a length of time or during flow control when by-passing the medium to the suction side of the pump.
- Monitoring of the surface temperatures of the pump casing at indicated areas (see figure 1) and controlling or monitoring the quench or flushing medium for the shaft seal normally ensures sufficient protection against potentially dangerous situations.
- Running the pump without liquid will quickly (matter of seconds) cause severe damage of the single seal arrangement without flushing. If any risk for dry running exists, flushing or quench solution should always be used.

## 3.0 Installation

### 3.1 Checks

Before installation, the equipment must be checked.

- Ensure the equipment data (as indicated on nameplate, documentation etc.) corresponds to the explosive atmosphere zone, category and system requirements.
- Possible damage: the installed equipment must be undamaged and must have been properly stored before installation. In case of any doubt or any damage found contact your local supplier.
- Ensure that heated air from other units will not affect the environment of the pump unit; environment air should not exceed a temperature of 40°C.
- The detailed check list (see 6.0) should be thoroughly followed.

### 3.2 ATEX certification

All additional equipment such as shaft couplings, guards, drive, motor, auxiliary equipment etc. must be part of the ATEX certification or must be certified separately for the appropriate temperature category. The assembled pump unit must have a separate certification and a separate nameplate supplied by the pump unit manufacturer.

### 3.3 Working environment

- The pump and unit must be accessible for maintenance and inspection during operation, see IM.
- Venting of air supply to the pump, drive and motor should be ensured.
- An electric motor should have a free inlet for cooling air of at least 1/4 of its motor diameter.
- The pump should be mounted with the shafts horizontally. Deviation from the recommended installation will influence draining, filling, venting and good functioning of the shaft seal, and the temperature distribution will be uncertain.
- Proper separate earthing facilities should be provided close to the pump unit baseplate.
- In hazardous areas the electrical connection has to be IEC60079-17 compliant.

### 3.4 Base plate

- The base plate must always be provided with an earthing boss.
- Ensure the earth circuit is properly connected to the baseplate.

### 3.5 Drive, shaft coupling and protection guard

- The starting torque of a rotary lobe pump is almost identical to the nominal torque during operation. The starting torque of the motor must be sufficiently high: the motor power is selected 20% to 25% higher than the absorbed power of the pump. If the starting torque is too low it will take longer to start the pump and the motor temperature could increase to an unacceptable level. When using a variable speed motor the cooling device of the motor must operate independently from the motor speed or must be guaranteed to be sufficient at its lowest speed.
- Follow the separate instructions for gear and motor drive and for explosion protected shaft couplings.
- When using a belt drive, ensure the belts have sufficient electrical conductivity to avoid electrostatic loads. Use only belts with electrical leakage resistance lower than 10<sup>9</sup> Ohm and avoid using aluminium or light metal pulleys containing more than 7.5% magnesium.

- The compulsory coupling guard must be included in the explosion protection certificate of the drive or pump unit or should be certified separately by the manufacturer or supplier of the guard. The coupling guard must be made of non-sparking materials. **Never use light metals containing more than 7.5% magnesium!** In case of aluminium coupling parts or belt-pulleys, the coupling guard must be made of brass.

### 3.6 Direction of rotation

- Rotary lobe pumps can run in both rotation directions.
- The pump unit's direction of rotation should be tested with the motor disconnected from the pump. Remember to secure or remove the shaft key in case of separate testing.



**Always align the coupling after having disassembled it and refit the coupling guard!**

### 3.7 Piping

- The suction and discharge lines should be designed properly for the required performance conditions and should be executed accordingly, see IM.  
Non compliance to the working conditions of the pump unit can cause severe problems such as NPSH-problems, vapour lock, excessive vibrations and premature pump failure.
- Lines should be checked on dimensions and tightness under pressure and should be internally cleaned and be free of welding and foreign particles before they are connected to the pump.

### 3.8 Shaft sealing auxiliary connections

The rotary lobe pumps allow the application of single or double mechanical shaft seals. In order to ensure proper functioning, venting and lubrication of the shaft seals, connections are available which will enable quench or flushing. For more information on the possibilities and connections see IM.

### 3.9 Check alignment

After installation the alignment of the pump shaft and drive shaft must be checked, preferably with the pump and the pipes completely filled with liquid, and must be corrected if necessary.

## 4.0 Commissioning

### 4.1 General

Take note that rotary lobe pumps are positive displacement pumps and procedures may often differ from procedures commonly used for centrifugal pumps.

Follow the instructions in the IM and the separate instructions for the motor drive and coupling.



**Ensure that all the shut-off valves are fully opened and the strainers are unclogged before starting up the pump!**

### 4.2 Precautions

For explosion protection the following precautions are of importance:

- Ensure that the area around the pump and the pump unit is clean.
- Ensure that the suction line is fitted securely and tight and is clean. Welding particles should be removed in advance. The whole pump system must be cleaned from particles.
- In case of SiC/SiC or carbon/SiC single shaft seal arrangement without flushing, the pump and the shaft sealing area must be vented and filled with the liquid to be pumped before any operation.
- In case of self-priming with quenched or flushed single/double mechanical shaft seal, the flushing/quench liquid supply must be monitored to prevent dry running of the shaft seal.
- Determine the direction of rotation with a switch on and off action of maximum 1 second to avoid dry running in case of single seal arrangement.
- Ensure the shutoff valves in the suction and discharge lines are opened at start-up.
- In case the pumped liquid needs to be heated, ensure the pump, shaft sealing area and the product to be pumped are sufficiently preheated before start-up.
- Shut down the pump immediately in the event of irregular operating modes or malfunction.
- Shut down the pump in case the flow drops or the pump pressure changes abnormally (i.e. lower or higher pressure). A flow decrease or pressure change is often a sign of malfunction, such as a clogged strainer, internal wear, etc. The cause must be found and repaired before the pump should be started again, see the Trouble Shooting list, in the IM.

Read "6.0 Limiting risks by means of check list" carefully as a complement to the above 4.2.

## 5.0 Maintenance

### 5.1 General

- Pumps certified for “Explosion protection” need maintenance and precaution to prevent risks of ignition due to malfunction and unacceptable wear.
- Follow the instructions given in the IM.
- A decrease of flow rate (or in case the pump does not supply the required pressure) is an indication of a possible malfunction or a sign of internal pump wear and requires maintenance or repairs. Other indications of internal pump wear is excessive noise during operating, vibrations or shaft seal leakage.

### 5.2 Gearbox

- Excessive noise, vibrations and heat built-up are indication of malfunction and premature failure of bearings and/or gear wheels.
- It is recommended to check bearings and vibrations by regular monitoring.
- Check oil level in gearbox, see IM.
- The axial clearance of the running internals is achieved by adjustment of the bearing assembly. For information about axial clearance adjustment, see IM.

### 5.3 Shaft seals

- The correct function and lubrication of the shaft seals must be checked regularly and dry running must be prevented.
- Several types of connections can be made to ensure proper quench, flushing, venting and lubrication, see IM.
- For single seals, not being quenched or flushed, the operator must ensure that the temperature of the seal area surfaces will not exceed the allowable temperature. If this cannot be ensured by the operator, monitoring devices should be installed.
- Quenched or flushed seals (single or double) have to be protected by controlling the quench/flushing liquid.

#### 5.3.1 Quench/Flushing (see IM)

##### **For a non-pressurised quench:**

- Check the level in the supply reservoir;
- Check the temperature of the quench liquid;
- Check the condition of the quench liquid by inspection: change the quench liquid in case it is heavily contaminated with leaking fluid.

**Note:** *Frequent contamination is an indication of an unacceptable shaft seal leakage, which should be repaired.*

##### **For a pressurised quench:**

- Check the level in the supply reservoir;
- Check the temperature of the quench liquid;
- Check the pressure.



**Take note: the quench liquid should always be pressurised while the pump is running, including at start and at shut-off periods.**

- Check the condition of the quench liquid: change the quench liquid in case it is contaminated with leaking fluid.

**Note:** *Contamination of the liquid is an indication of irregular or faulty operation and should be inspected. E.g. the mechanical seal at medium side may be leaking or may be opened due to insufficient counter pressure of the quench liquid.*

## 6.0 Limiting risks by means of “check list”

### 6.1 During installation

- Check that the pipes are correctly connected and self supported. The pipe system should not exert excessive forces on the pump connections during operation, including weight of liquid, reaction forces and thermal expansion – have separate pipe supports and compensators been provided for?
- Check the flange seals on the suction and pressure pipes.
- Check auxiliary circuits to seal system such as heating device, quench and flushing solutions.
- Check that no solid particles can enter into the pump – pipes must be cleaned after welding, possible presence of residues in the pipes must be eliminated.
- Check the alignment of the rotating parts between motor and pump after complete installation.
- Check the rotating direction of the motor, after completed installation, in relation to the suction and pressure direction of the pump. Perform the test with the motor detached from the pump.
- Check that the pump unit (motor, pump and baseplate) is thoroughly earth grounded.
- Check the status on all electrically/ electronic devices such as sensors, data loggers, frequency converters etc are in accordance with the applied ATEX regulation.

### 6.2 Before starting the pump

- Have all plugs and connections been sealed and tightened?
- Have the screws of the pump flanges been tightened?
- If relevant, is the safety valve trimmed for the right pressure?
- If relevant, have the pump been sufficiently warmed up before start up?
- Has thermal expansion or contraction of the liquid been provided for when heating up or cooling down.
- If relevant, is the installation and operation of the quench respectively the flushing system of the pump seal arrangement overlooked and tested?
- Have the protections against rotating parts been correctly mounted?
- Are the suction and pressure valves opened?
- Is the pump completely filled up with liquid if single seal arrangement is installed?
- Is the quench or the flushing system in proper operation if pump starts dry?

### 6.3 When starting the pump

- If relevant, start up auxiliary equipment, e.g. quench or flushing pressure and flow.
- Check that the pumps outlet and inlet valves are opened.
- Start up with sufficient start-up torque.
- Start up at low speed if speed regulator is used.
- Stop the pump if the safety valve opens or the outlet pressure rises too high.



## 6.4 When the pump is running

- Never close completely the suction valve or regulate the capacity/pressure by means of it.
- Never close outlet valve completely without a safety valve installed – stop the pump by electrically disconnect the motor.
- Check the correct operation of the auxiliary circuits, including: quench, flushing, heating.
- Check for leakage and apply measures if necessary.
- Clean up any leakage and trace the cause of it.
- Check and evaluate regularly the data relevance from installed sensors.
- Regularly check and clean up dust accumulation on the pump unit and its surroundings.
- Regularly check and take measures for abnormal vibrations on the pump unit and the pipe system.

## 6.5 When stopping the pump

- The pump can run as a turbine, if check valve is not installed, on the influence of a static or accumulated pressure difference, in which the liquid flows back towards the suction side; put measures in place if this is not acceptable.
- Allow for thermal expansion or shrinkage of the liquid when heated up or cooled down.
- Try to stop the pump slowly and/or with reduced flow to avoid pressure transients (high energetic pressure spikes) in the pipe system.

# TopWing

EXPLOSION PROTECTION  
ACCORDING TO ATEX (94/9/EC)



## **SPX FLOW TECHNOLOGY SWEDEN AB**

Nastagatan 19, P.O. Box 1436  
SE-701 14 Örebro, Sweden  
P: +46 (0)19 21 83 00  
F: +46 (0)19 27 23 72  
E: johnson-pump.se.support@spx.com

SPX reserves the right to incorporate our latest design and material changes without notice or obligation. Design features, materials of construction and dimensional data, as described in this bulletin, are provided for your information only and should not be relied upon unless confirmed in writing.

Please contact your local sales representative for product availability in your region. For more information visit [www.spx.com](http://www.spx.com).

ISSUED 12/2011 A.0501.301 EN  
COPYRIGHT ©2011 SPX Corporation